

Wired electro-installation

Smart home & building solutions



www.inels.com

INELS[®]

ELKO EP



We are traditional, innovative and purely Czech development manufacturer of electronic devices and we have been your partner in the field of electroinstallations for 26 years.

ELKO EP employs about 330 people, exports its products to more than seventy countries, and has representatives in thirteen foreign branches. Company of the Year of the Zlín Region, Visionary of the Year, Global Exporter of the Year, Participation in the Czech TOP 100, these are just some of the awards received. Still, we are not finished. We are constantly striving to move forward in the field of innovation and development. That's our primary concern.

Millions of relays, thousands of satisfied customers, hundreds of our own employees, twenty six years of research, development and production, thirteen foreign branches, one company. ELKO EP, innovative- a purely Czech company based in Holešov, where development, production, logistics, service and support go hand in hand. We primarily focus on developing and manufacturing systems for building automation in the residential, commercial and industrial sector, a wide range of Smart city facilities and the so-called Internet of Things (IoT).



Facts and stats

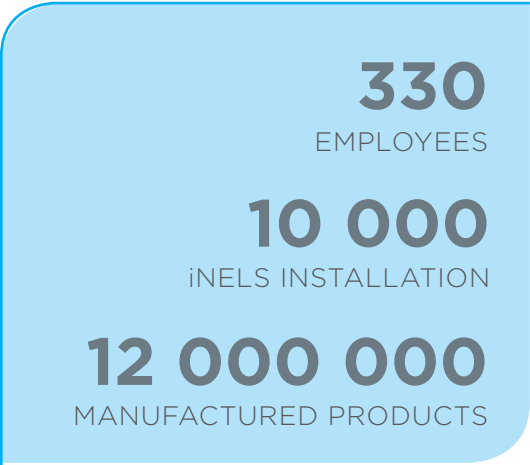
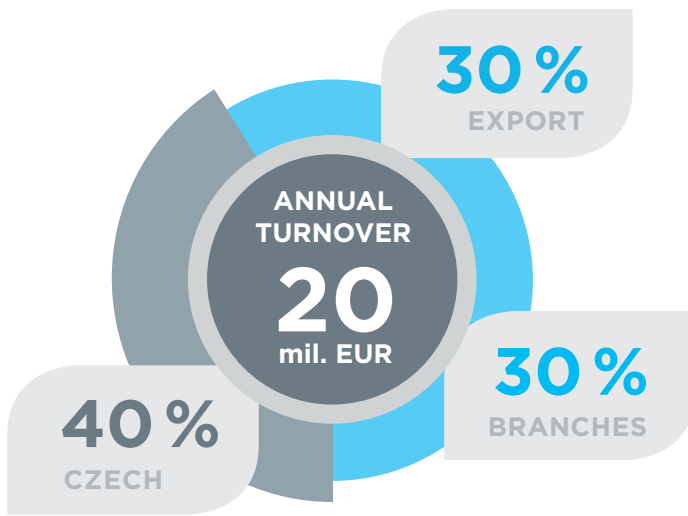

WE ARE



DEVELOPERS

In the new R&D center, more than 30 engineers develop new products and extend the functionality of existing products

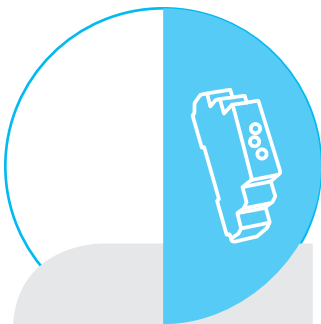

PRODUCERS

modern antistatic spaces, 2x fully automated SMD production lines, 2 shift operations.



SUPPORT

24 hours / 7 days / 360 days we not only provide technical support but also logistics.



SELLERS

personal access to more than 70 sales representatives in ELKO EP Holding provides impeccable services and superior products at an affordable price.

Why a Smart Building?

The requirements for modern electrical installations in homes and buildings have recently changed considerably. Increasingly, the emphasis is on savings, safety, comfort and user friendly control.

With this the increasing amount of technologies and equipment, which equip homes and buildings, have thereby increased the number of separate systems which are required to cooperate with various controls. For users it is very difficult to orientate themselves with the individual controllers and the individual technologies are not communicating effectively. This can lead to highly inefficient operations of the various buildings.

The solution is a system of home and building automation called iNELS. iNELS main advantage is that it can operate over a very wide range of technologies, for which, it offers a unified user interface. Not only allowing the operator to eliminate a variety of disparate individual technologies, but thanks to iNELS it is possible with a single device, to both control centrally and remotely all the connected technologies.

Thanks to the open protocol, in the commercial sector iNELS can be also integrated into the Building Management Systems (BMS).



Savings

- by efficient control of HVAC systems, it is possible to attain savings of up to 30%
- lighting control lets you save around 15%
- the aim is to achieve thermal comfort and lighting inside the building for the most efficient operation of the building



Security

- the system includes security with motion detectors, access, fire alarm system with smoke detectors and temperature, access to the intercom, card readers and camera system
- these technologies greatly enhance the sense of security for the users of the building



Comfort

- you can control comfortably entire system from one location – computer, smartphone, tablet or panel
- central and remote control of operator is very effective way to ensure the efficient and uninterrupted operation of the building



Integration

- the main idea is to integrate all technologies into one system and the main goal is to offer a single interface for all the disparate technologies
- integration of third party technologies brings numerous benefits and the communication between each technology further increases the efficiency of the buildings



Automation

- automation of many processes in the building has a positive effect on the efficiency of its operation and the convenience of use
- utilizing a number of sensors and further system information processing leads to the automation of HVAC, lighting, shading, and other technologies



Flexibility

- the flexibility of the system is its modularity and options for responding to user requests easily without impacting on construction
- control methods can be easily adapted to changes in the method of use of the building e.g. when required by tenants

One system, one application, for the whole house

Video cameras

Through the application in smartphones, tablets or televisions, you can browse through images of IP cameras



Light scenes

With just one button on the controller, you can simultaneously control multiple devices (light scenes, all off, nighttime hallway, etc.)

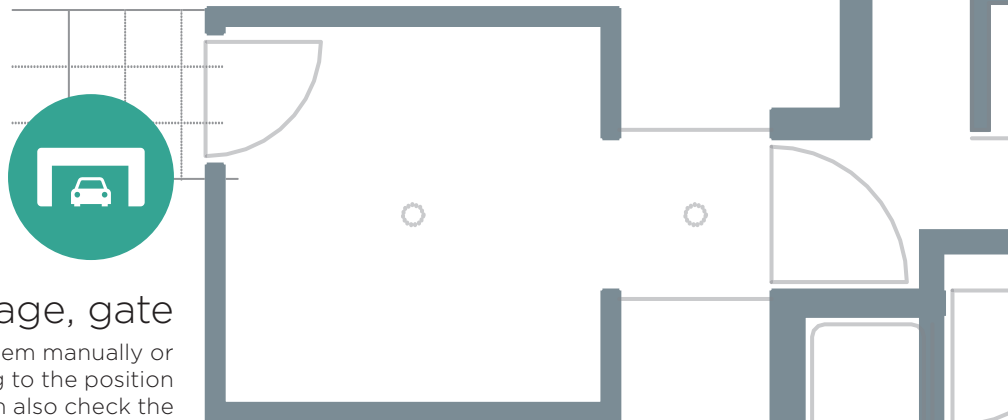

Garage, gate

It is possible to control them manually or automatically according to the position upon reach. Residents can also check the status and position.



Watering

It is possible to predefine a time mode in the system for watering in relation to temperature and moisture. You can control circuits manually from the application as well.

Macro functions

System is able to automate a lot of events, such as if the light is on, the shutters go down.



Door communicator

Door communicator offers the possibility to call to internal devices such as panel, tablet, smartphone, TV or LARA. Thanks the verbal and visual communication it greatly contributes to make users feel safer.



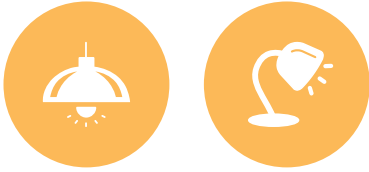

Lighting

Simple switching or dimming of various types of light sources including LEDs and even coloured RGB strips.

LARA

Manage your audio in every room from the application and enjoy comfort of multi-room solution.



Blinds and shutters

Actuators enable control of various types of shading technology. It is possible to set dependent programs in a time mode, light scenes, or to control manually.

Measuring energy

Measured values of consumption of electricity, water and gas are stored to the database and transmitted to the application.



Security

The system include detectors, such as motion, magnetic, smoke, forming the basis of the security alarm system. The water leakage sensor warns against flooding in the bathroom or an overflowing reservoir.



HVAC Control

Controlling heating, ventilation and air conditioning systems allows to control temperature individually in every room.



Appliances

Switching according to set mode or manually from the application or from any system controller.



Weather station

Information from the weather stations helps with protecting external shutters, positioning blinds or watering garden.

You can control your devices in various ways

To control iNELS a variety of options can be used and because the technologies are interconnected, it is up to the user which concept is chosen.

The concept is elected primarily by the type wiring used in the building. Other considerations regard the controlling of an apartment or villa and again others in case of installation in a hotel complex or office building. The operating concept should provide users with the desired comfort, but should remain simple and user-friendly.

Generally, it is possible to control use the following options, which can be combined to create several levels of control from very simple local control of wall switches for standard users, via touch panels offering very interesting possibilities for hotel rooms or meeting rooms, and finally through an application for smartphones phones or tablets, to a web application used to really complete the management and oversight of the whole building.

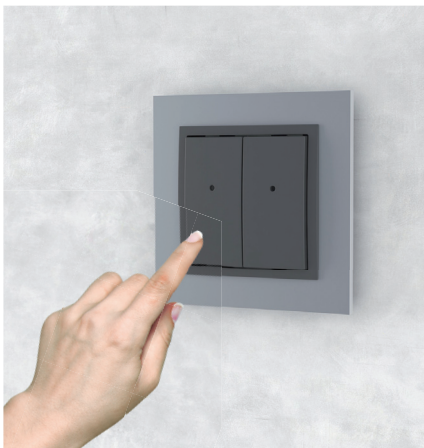

Wall controller

- intuitive switch with a premium design
- can be switched, dimmed or used to controlled shading scenes
- measures temperature and signals the state
- functions can be easily modified



Glass switch button

- luxury glass design in black or white
- also available in a version with RFID reader
- senses the ambient light intensity
- vibration indicator when pressed

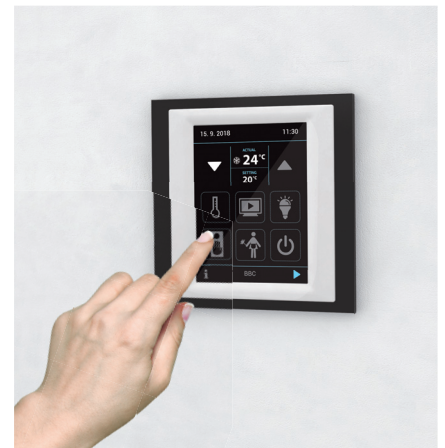

Elko hotel touch screen

- design element with a touch of luxury that enlivens every interior
- used for scene control, temperature, and lighting colour
- hotel option also controls the music settings
- colour 3.5 "TFT display

You can control iNELS with:



Wall controller

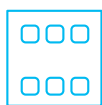

Glass switch button

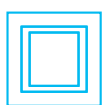

Elko touch screen



Smartphone



iNELS touch panel 10"



BMS software



Smartphone

- IHC application provides a user interface for all connected technologies
- remote control of the system via the Internet
- application iHC iNELS is just the right size
- is a free download on Google Play and the App Store



iNELS touch panel 10"

- used to control the iNELS system from the comfort of your home
- you can use Android and iHC applications or the booking system for your training, meeting room



BMS software

- in large commercial buildings iNELS is ready for integration into the BMS (BAS) or PMS
- open communication protocol makes iNELS a truly universal solution

For which types of buildings is iNELS intended?

iNELS BUS system, due to its modularity and flexibility is designed for use in almost all types of buildings. The proper and efficient design of the space brings several advantages over standard wiring. This is not altered by the fact that most of the equipment, the system including wiring are invisible to the user. Our aim is to facilitate people's lives while also thinking of the environment.

Experience and the projects of our customers constantly prove that the installation of iNELS is effective for small, relatively simple installations in flats or apartments, and also in large hotel and commercial complexes. In each of these types of buildings standardized solutions can be used and investors can easily offer several distinct cost and functional solutions. The modularity and flexibility iNELS also offers a wide range of options for creating unique new concepts and approaches to managing the projected area.

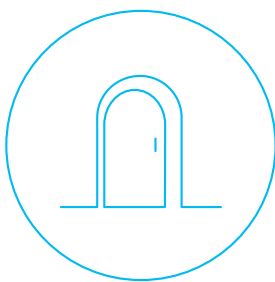

Apartment

Installing smoke detectors, flood sensors or motion detectors dramatically increases the feeling of safety. The ability to modify the lighting atmosphere and the intensity of colour in turn increases comfort.



House

The effective management of shielding technology today allows not only the adjustment of lighting conditions inside the house, but can also affect the heating or cooling.



Villa

The effective management of heating and cooling systems to maintain the desired thermal comfort while doing their best to minimise energy consumption is very important.



Hotel

The system provides access to hotel rooms and a wide range of automatic functions based on the presence of guests, with an emphasis on the effective management of energy consumption.



Commercial

Different solutions are also used in the context of sports and wellness centres, restaurants, offices, meeting rooms, cultural exhibitions, manufacturing halls or warehouse space.





FLAT

Protect everything you love

Despite the various ranges of wiring solution iNELS brings to the housing unit a number of options to simplify daily activities and give a feeling of safety to the occupants. A major advantage is the flexibility of the system, appreciated by everyone – users, owners and developers.

The kitchen is a room equipped with a wide range of appliances, without which people cannot imagine life. Apart from the benefits brought by the hob, the electric kettle and toaster these can also be a source of unpleasant situations. While these situations may not occur regularly or often, that simply makes the surprise more unpleasant. To completely eliminating or at least significantly reduce damage it helps to install a smoke detector that provides a warning of smoke spreading due to burning or smouldering.



Combined detector

DMD3-1

DMD3-1 is a combined detector for ceiling mounting. The unit is equipped with two communication interfaces: installation iNELS BUS and DALI. Using the passive scanning infrared spectrum for detection .



Motion detector

MD-100

It is based on motion detection it automatically controls lighting or triggers an alarm.

Apartment

Ambience with just one touch

For a long time lighting control has been limited to simply switching on or off. The iNELS solutions offer a variety of options that users can enable, automation, savings and ease of setting the required lighting atmosphere.

Dimming, scene and colour selection: These three concepts provide users complete freedom when designing any interior. The possibility to simply select the appropriate ambience for the activity provides users with pleasant comfort, especially when they can choose a pre-set scene with one touch. It is completely up to the user at what intensity or colour you wish to set all fixtures operating for different scenes, e.g. for reading, for relaxation, watching TV or visiting family or friends. Each scene can be completely personalized and can at any time during use simply be change only by software modifications - there is no need to do any construction work.

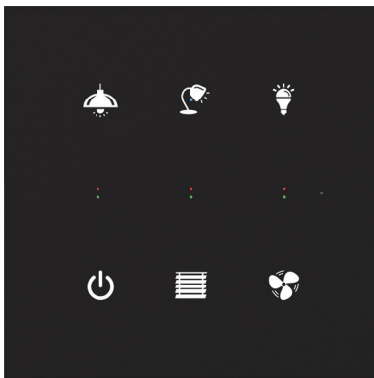

Glass switch button with symbols

GSB3-40/60/80/SB

Luxury glass touch control in three versions with four, six or eight buttons are available in elegant black and white. Switches also sense the ambient lighting and offer a choice of symbols.



Elko smart touch screen

EST3

Touch unit with colour 3.5" display offers three control screens. The first controls the temperature in the room, the second the RGB colour light resources and the third allows the selection of the 4, 6, 9 or 12-button array.





Apartment building

iNELS brings people together

Modern wiring is not limited to the walls of housing units. Its true benefits are apparent when we decide to fully exploit its potential, i.e. when its functions will be used throughout the building.

Modern IP intercoms provide options that are not possible to implement with original analogue systems. When selecting the intercom with a camera at the entrance to the building a significant safety feature is enabled. At this point there is a connection to the iNELS system installed in residential units. To answer an incoming call from the intercom the intended device is the LARA Intercom, which has surprising dimensions and features. The equipment the size of a switch plays Internet radio and music, enables two-way voice intercom communications, including receiving the camera's image. The user is now able to verify the identity of the person at the entrance; this is the deciding safety feature.

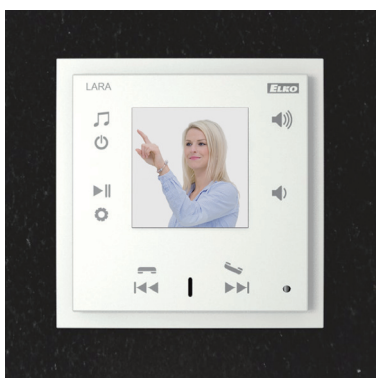

LARA Intercom

Intercom unit for receiving calls, including the camera image. There is the possibility to open the door to allow entry to the building directly via the front panel buttons.

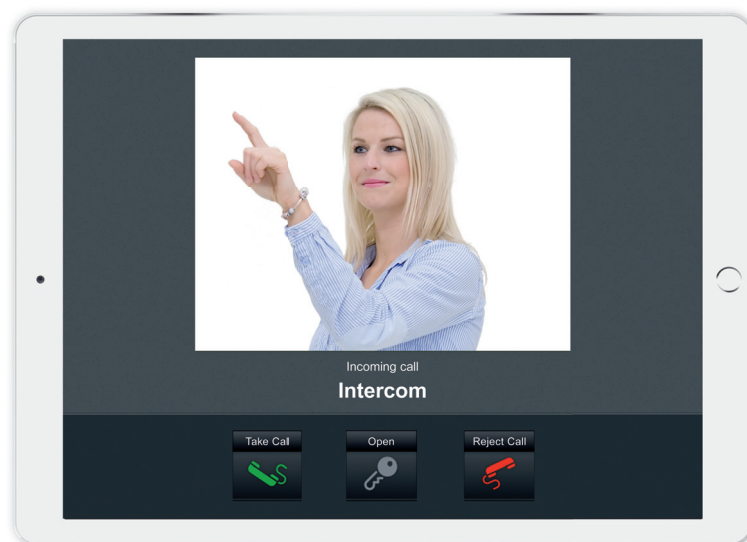

Application iHC

Calls can also be received through the iNELS Home Control applications installed on the touch panel located on the wall as a central control panel for the entire electrical system.

Door communication solution

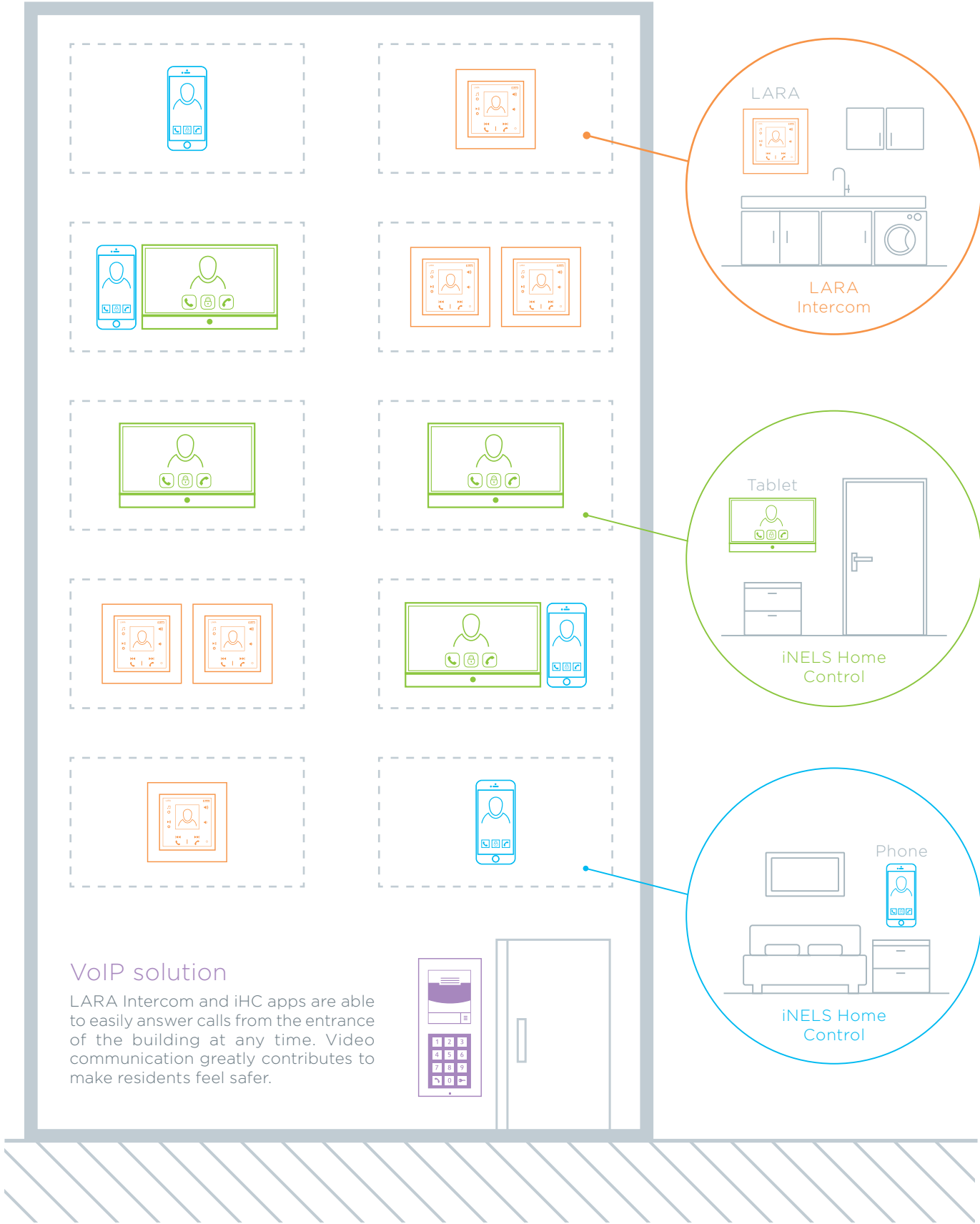

VoIP solution

LARA Intercom and iHC apps are able to easily answer calls from the entrance of the building at any time. Video communication greatly contributes to make residents feel safer.

House

Everything runs automatically based on the information received

Effective management of shading techniques such as blinds, shutters and awnings, it is very important not only from the perspective of light in the house, but also in terms of potential savings in the management of heating and cooling in different seasons.

Management of shutters or blinds from local wall switches are standard, as is the use of short-presses to tilt the slats and long presses for a complete pull out or pull back. The iNELS solution allows individual shutters or blinds themselves, or organised into various groups to be controlled. Pressing one button (or icon in the application) controls the scenes. Groups can also be individually adjusted without any manual intervention of the electrical wiring.

A really interesting dimension in control, however, comes with the use of automatic time programs and the installation of an outdoor weather station. It can control blinds automatically – it can tilt the slats according to the position of the sun, it can pull roller blinds (retract the awning) when the wind rises above a critical level. It can also inform the irrigation system, whether it is raining or not.



Weather station

Clima sensor D WTF

The professional weather station provides up to eight measurements about outdoor weather conditions – rain, wind, temperature, relative humidity, Twilight, intensity east/south/west. The unit is connected via ADC3 units.



Irrigation



Awning

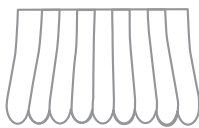

Blinds/Shutters

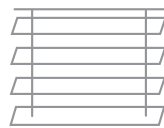

Heating/Cooling

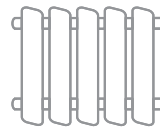

Lighting



iNELS Home Control



Central unit



Weather station

Villa

Individual temperature control

Thanks to the iNELS solution each room is always at the perfect temperature. Now the efficient management of heating and cooling systems is a means to achieve the greatest savings in energy consumption.

A house or villa can be heated and cooled entirely automatically based on user pre-set time regimes for individual rooms. The big advantage of intelligent management is the mutual communication between the heating and cooling systems, this negates the possibility that the house will heat and cool at the same time, as can often happen with the installation of two independent systems.

The user always has the villa under control and the temperature can be adjusted whenever required. To adjust the temperature, the thermostat may use locally or by remote access using the iNELS Home Control.

The user has the possibility to visualize the amount consumed during different time periods, so that their bills are always under control.



iNELS touch panel 10“

Versatile touch control panel is usable for full household control, compatible with wireless and BUS wiring.



Heating

Screen to control heating and cooling offers a variety of options for adjusting the desired temperature precisely according to customer requirements.



Air conditioning

Thanks to full integration the screen provides control of air conditioning with a full range of options. The iNELS solution understands dozens of manufacturers of these systems.

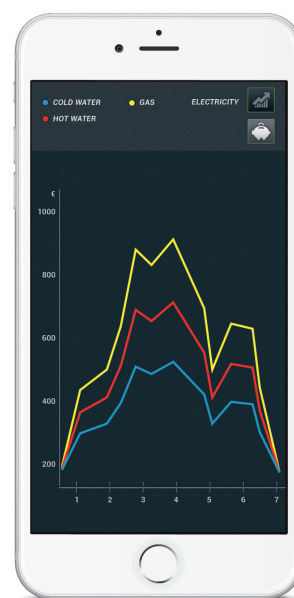

Energy measurement

It is very easy to view the amount of energy consumed during different periods and therefore have their energy bills more under control.



Hotel

You'll feel right at home

iNELS solution for guest room management is designed to help create an environment that allows guests to feel as if they were at home. The hotel room always welcomes guests with a pleasant temperature and the controls offer a very simple to use option for creating the atmosphere currently wished for.

Every detail contributes to the overall satisfaction rating and the first element, with which the host comes into contact with, is the RFID card reader for entry into the room offered in an attractive glass design. Readers come in a sleek black or white design. To set the desired atmosphere in the room a touch panel is available with a very intuitive user interface for the control of temperature, lighting, shading, or setting the music scenes. Scenes can also be activated automatically upon entering the room. The iNELS solution is the subject of guest comfort, but it also strives for the effective management of all technologies, which significantly contributes to saving energy consumption.

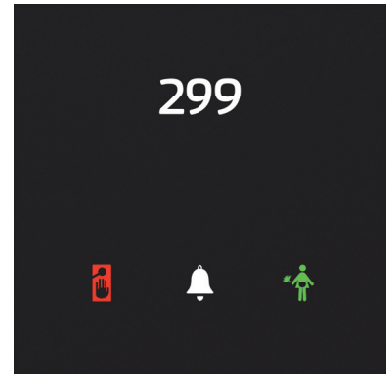

Glass card reader

GCR3-11/B

The RFID card reader is a great design for the entrance to the rooms which also features a bell signal the "Do Not Disturb" and "Make Up Room" signs. Thanks to the integrated relay it can control the door lock directly.



Elko hotel touch screen

It provides the ability to control lighting, blinds, lighting scenes and multimedia with a colour 3.5 „display and a user-friendly interface.

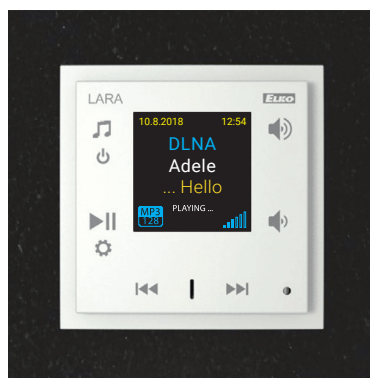

LARA Radio

The compact device for playing music and Internet radio streams from around the world. Thanks to the LARA unit every guest will feel welcome and at home during his visit.

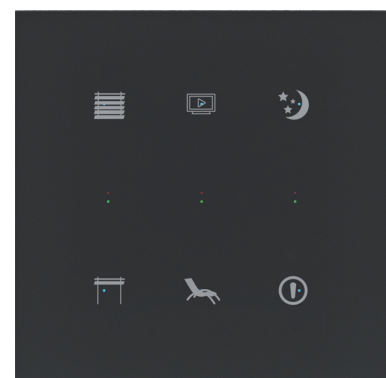

Glass switch button with symbols

Customizable touch control solution for lighting control and other technologies in different scenarios e.g. reading books, relaxing, watching TV, Master Off.





Sport and wellness

You only need to think about yourself

In commercial premises used for sports or relaxing by the general public the emphasis is on user-friendliness, but functionally it is a very sophisticated system access control, with automation, lighting, distribution of audio content into individual zones and the possibility of central and remote monitoring.

iNELS meets all of these requirements. RFID Readers allow people to control access to individual parts of the building according to clearly defined rules, e.g. On the basis of specific services required. Of course there is the automatic lighting control based on motion information. There is an endless array of possibilities which iNELS offers, the control of lighting in wellness centres, in which are widely used colour and the dimming lights for a variety of scenarios. Individual rooms can share music centrally. From reception or another central location it is possible to supervise not only the features described above, but also a camera or alarm system.



Gateway iNELS - DALI/DMX

EMDC-64M

The unit is the gateway between iNELS and digital lighting protocols DALI and DMX. Thanks to EMDC it is possible to create beautiful light sceneries e.g. in wellness centres.



Restaurant

Ambience set easily according to personal requirements

Thanks to the setting of lighting scenes iNELS can create the right atmosphere in a restaurant or bar. Not only the ability to adjust the brightness to a certain level, but also perform colour mixing in RGB LED strips and spotlights.

You can also adjust the air temperature for the different zones, according to the movement of guests and staff. The newly opened showroom iNELS Café in Prague can even host your table set according to your actual needs - business lunch, romantic dinner, and party. Food can be ordered directly from the touch screen at the table. Of course, music and video is distributed to all areas including the toilets.



Universal dimming actuator, 2-channel

DA3-22M

Versatile dual-channel dimmer controls the intensity LEDs, ESL and RLC light sources and allows you to create the desired ambience.



Dimming actuator for LED sources, 3-channel

DCDA-33M

The triple-channel dimmer for LED light sources controlled by a variable current is being used for controlling orientation or indirect lighting.



Switching actuator, 4-channel

SA3-04M

Not only setting the intensity and the colour light sources forming the atmosphere. iNELS offers a number of SA3 actuators for switching of all types of lights sources.





Historical building

Wireless, here to help you

The benefits of iNELS can be used in historic buildings where the main electrical requirements include stage lighting and quality air circulation, security of property and exhibits.

With BMS it is possible to combine a wireless controller and sensors of temperature and humidity, especially where due to the historical value of the equipment you cannot hack or otherwise interfere with the walls and tiles. In the case of publicly accessible annotated guides and exposures there is the option via phone applications to run an interpretation of the scene accordingly. Including the accompanying comments on Audio-zone.

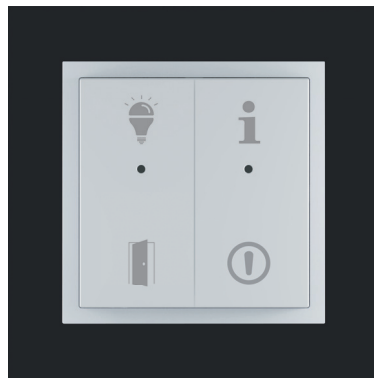

Wireless wall controller

RFWB/WSB3

For scene control (lighting, music, and projection) it is also possible to use flat wireless switches, which thanks to customizable printing offers clear control.



Wireless remote controller with display & 4 button controller - keychain

RF Pilot/RF Key

Ideal for controlling technology in areas where it is not possible to carry out construction work, are the portable RF and RF Pilot Key controllers.

Offices

Effective access control system

The system controlling entry to the building and to the individual zones is a key factor that affects the safety of people, property and information. Automated control technologies, such as lighting, HVAC and shading again provide the optimum working environment while efficiently using energy.

Installing RFID card readers, in elegant glass design, can ensure that only authorized persons entry into each zone. This event may also be associated with performing certain scenarios within the work place of the person, e.g. during morning arrival. A major theme is the automation of the various reservations of meeting rooms and the scenes in them for certain activities, such as, business meetings, lectures, videos, etc.).

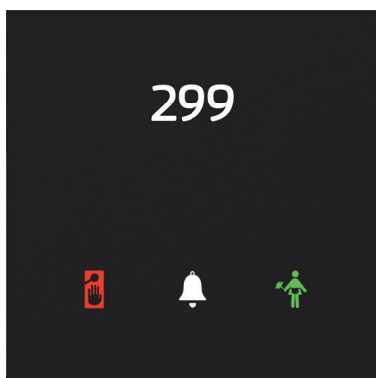

Glass card reader

GCR3-11/B

The RFID card reader is a great design for the entrance to the rooms which also features a bell signal the "Do Not Disturb" and "Make Up Room" signs. Thanks to the integrated relay it can control the door lock directly.



Combined detector

DMD3-1

Ceiling motion detector switches lights based on detecting movement inside. It is also equipped with a illuminance sensor for automatic regulation.





Production hall, warehouse

Lighting control to reduce costs

Paramount In production areas and warehouses is efficient lighting control. iNELS enables management and control of each luminaire whether with your own the BUS, DALI or DMX.

Lamps can be controlled by time, human presence, the intensity of outdoor (natural) light or only as needed (areas) – all these control methods can be combined together. For monitoring you can use a camera system and makes it possible to integrate resources for heating, air conditioning. iNELS also allows the measurement of energy, including monitoring of critical values.



Gateway iNELS - DALI/DMX

EMDC-64M

Thanks to EMDC it is possible to operate the extensive DALI lighting systems e.g. in the store, where you can create and change zones according to your actual needs.



Analog-digital converter

ADC3-60M

Analog-digital converter are used to connecting the wide range of sensors with analogue signals. Light intensity sensors or air-quality sensors can be very easily integrated.



Switching actuator, 12-channel

SA3-012M

Switching units are the basis of each project and due to the number of outputs the SA3-012M is highly cost effective solution for big projects.

The most complex system

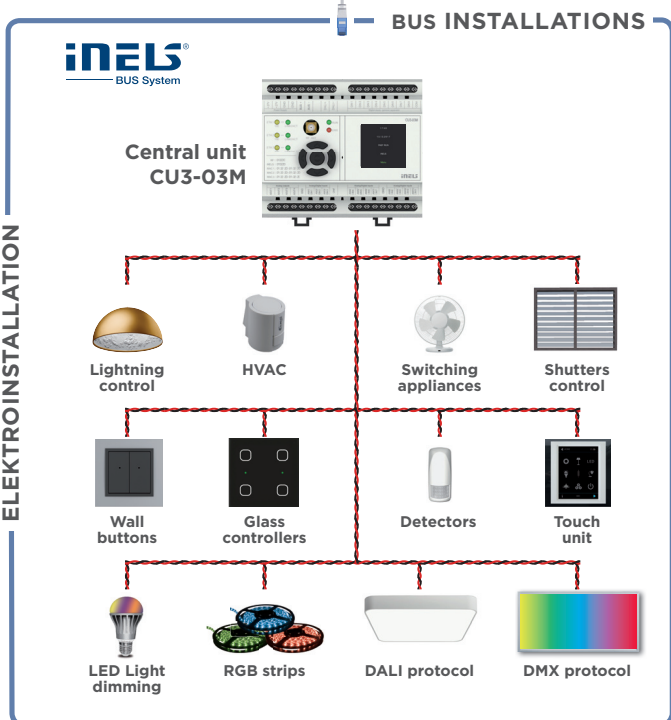
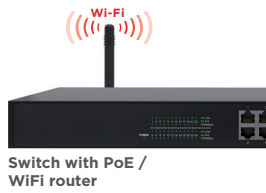
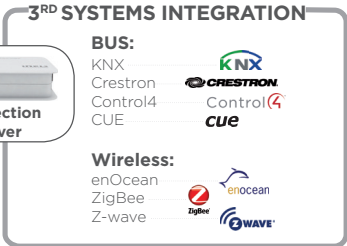
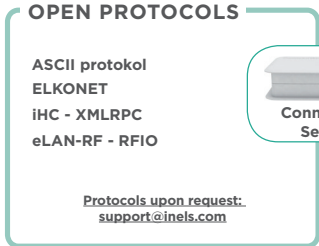
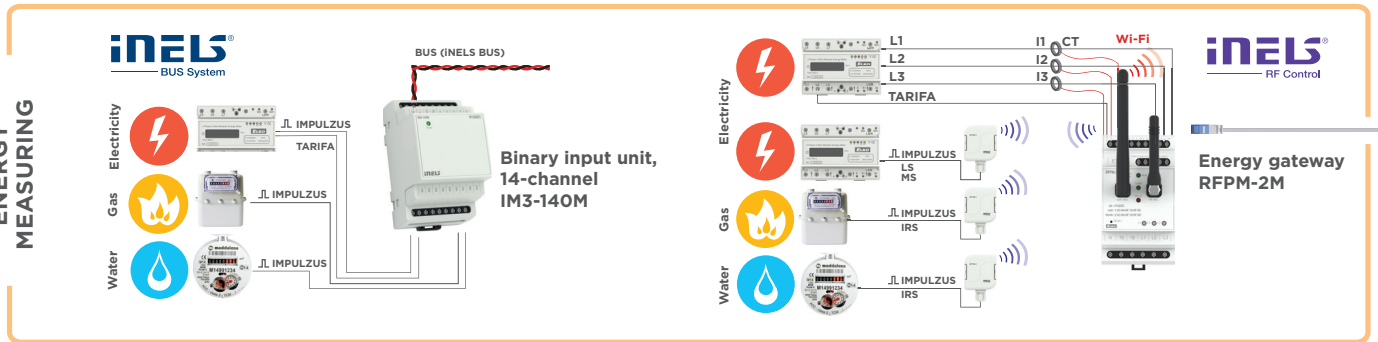
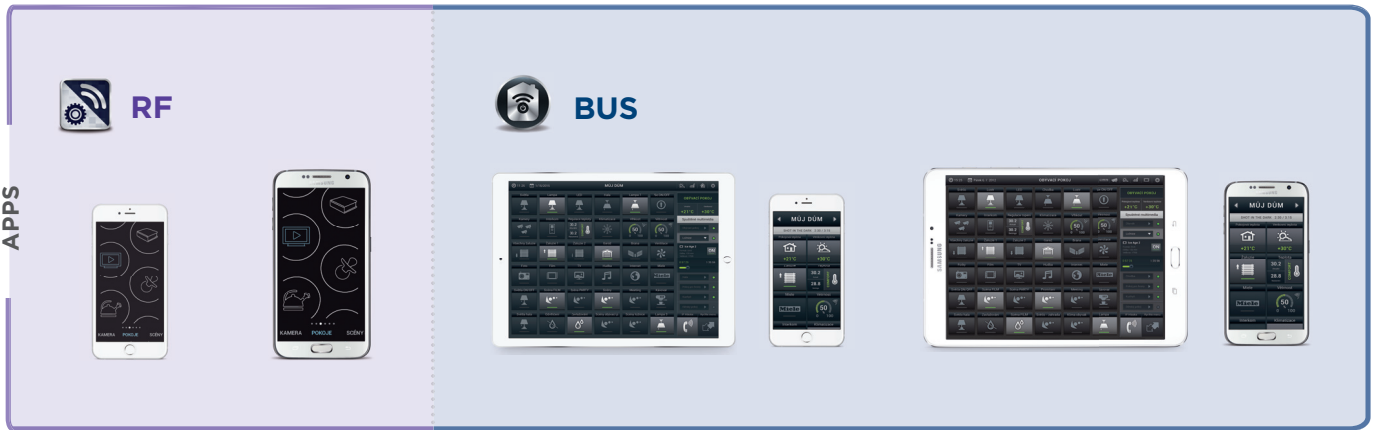

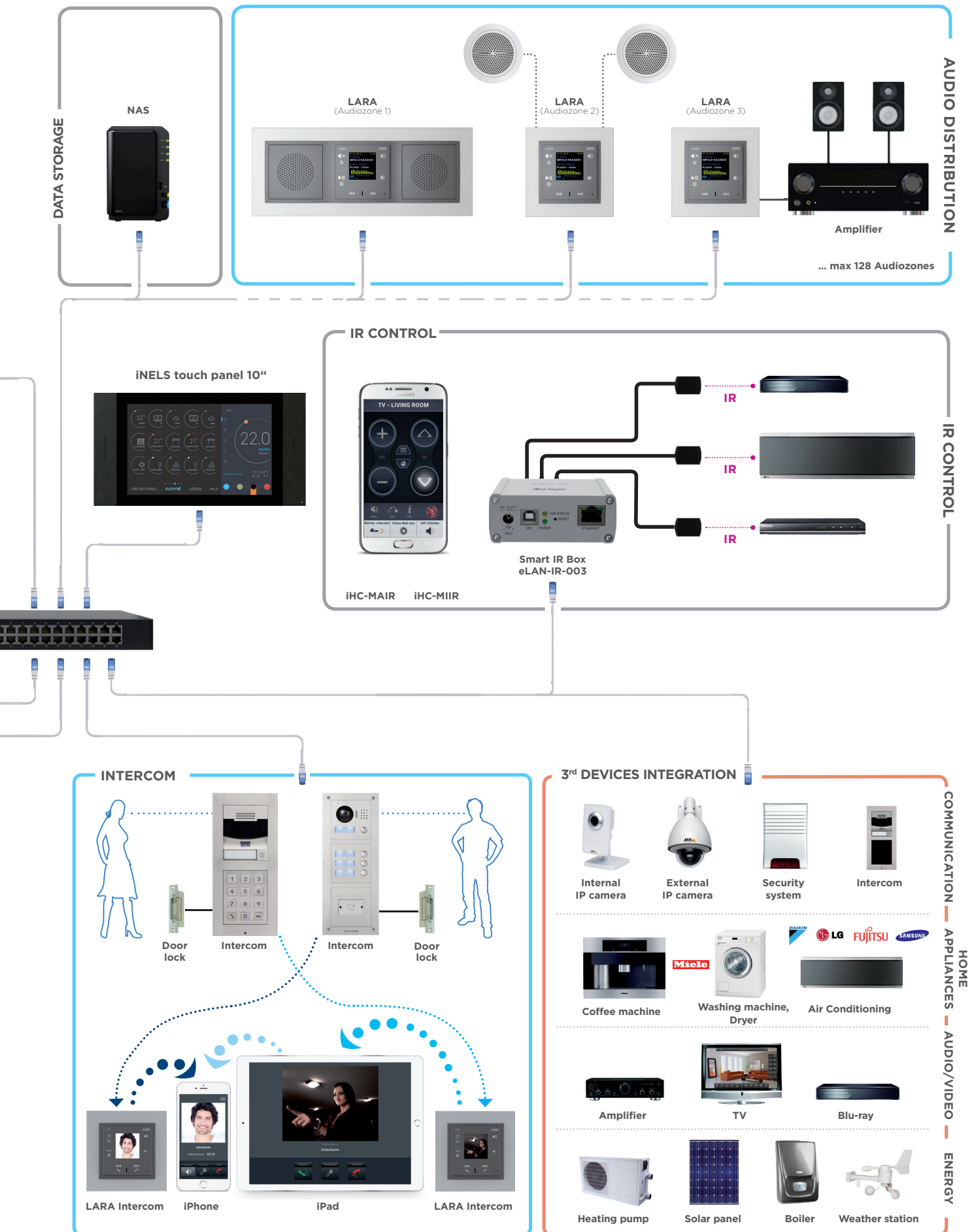

Guest room management system

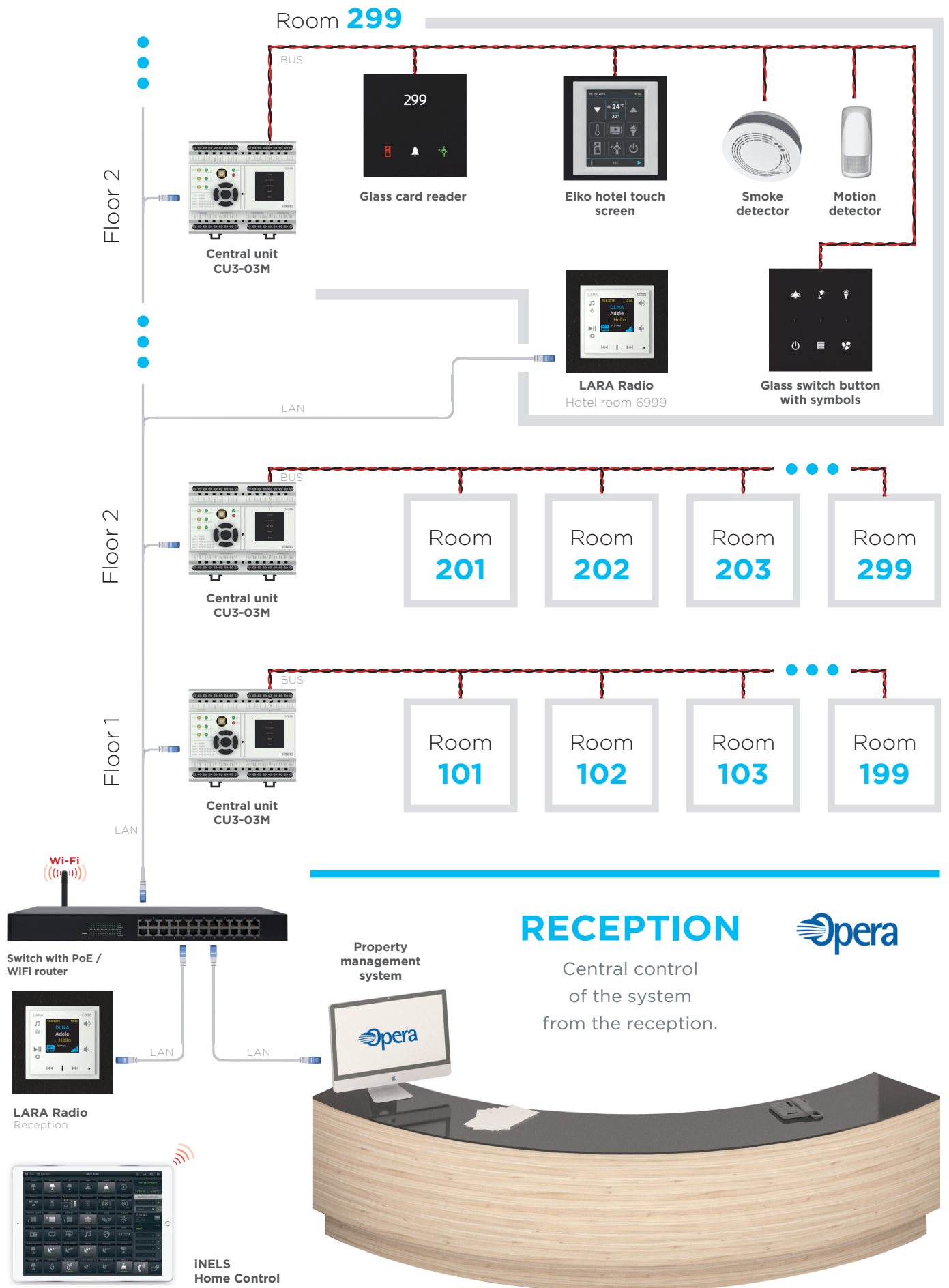

RECEPTION



Central control of the system from the reception.

Intercom & videophone & audio

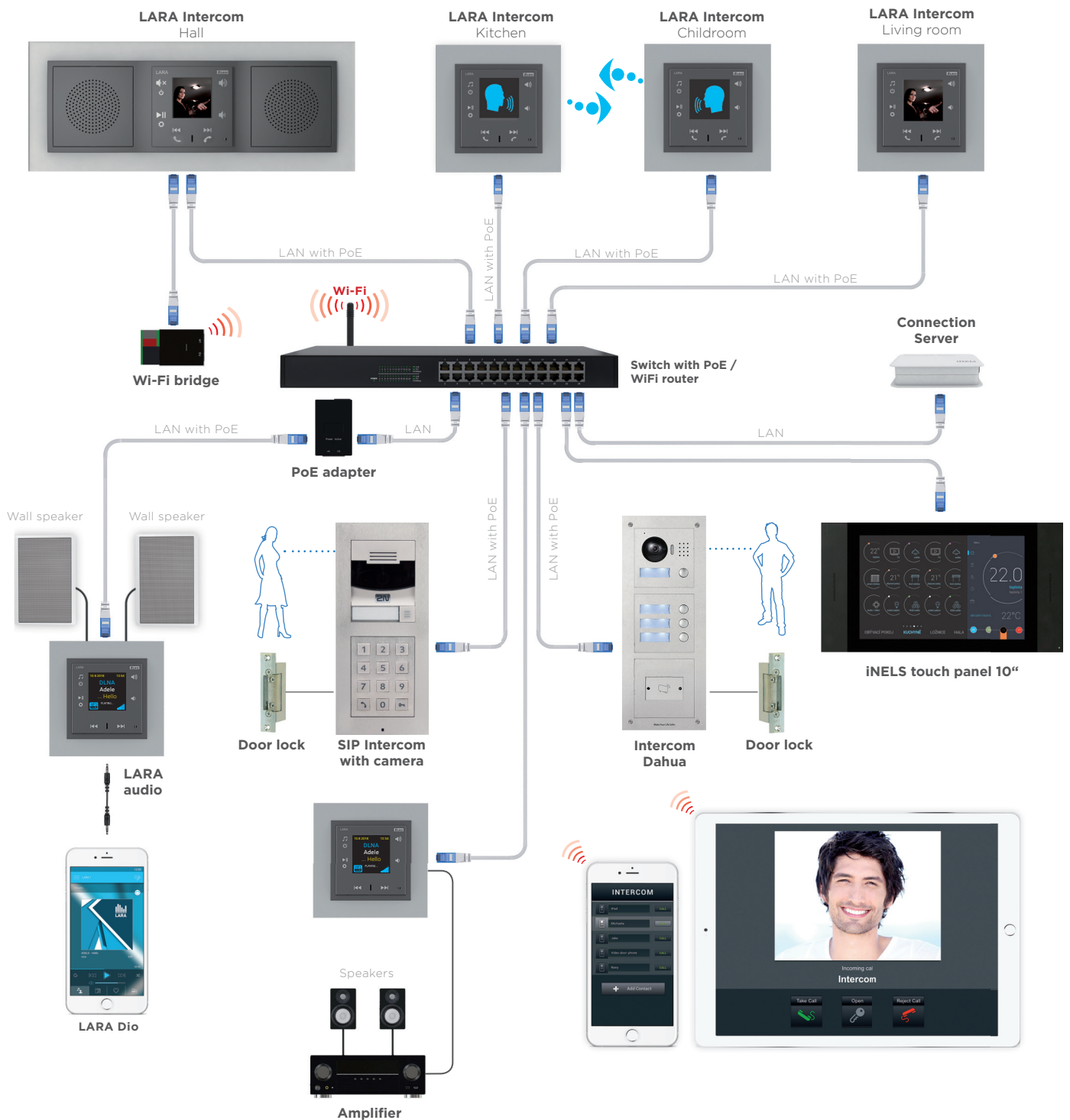

LARA Intercom functions:

- videophone – communicates with the IP door communicators (audio)
- intercom – communicates with the other LARA units in the different rooms
- radio – play a stream of internet radio
- music – play a music from iPhone, MP3

player etc. (using a 3.5 mm stereo input jack on the bottom of the front panel)

LARA audio outputs:

- internal amplifier 2x 10 W / 8Ω
- line output 2x 1V

iNELS VoIP solution:

- it is possible to communicate between:
 - LARA Intercom units
 - IP intercoms
 - iHC apps in smartphones
 - iHC apps in tablets

IP Cameras

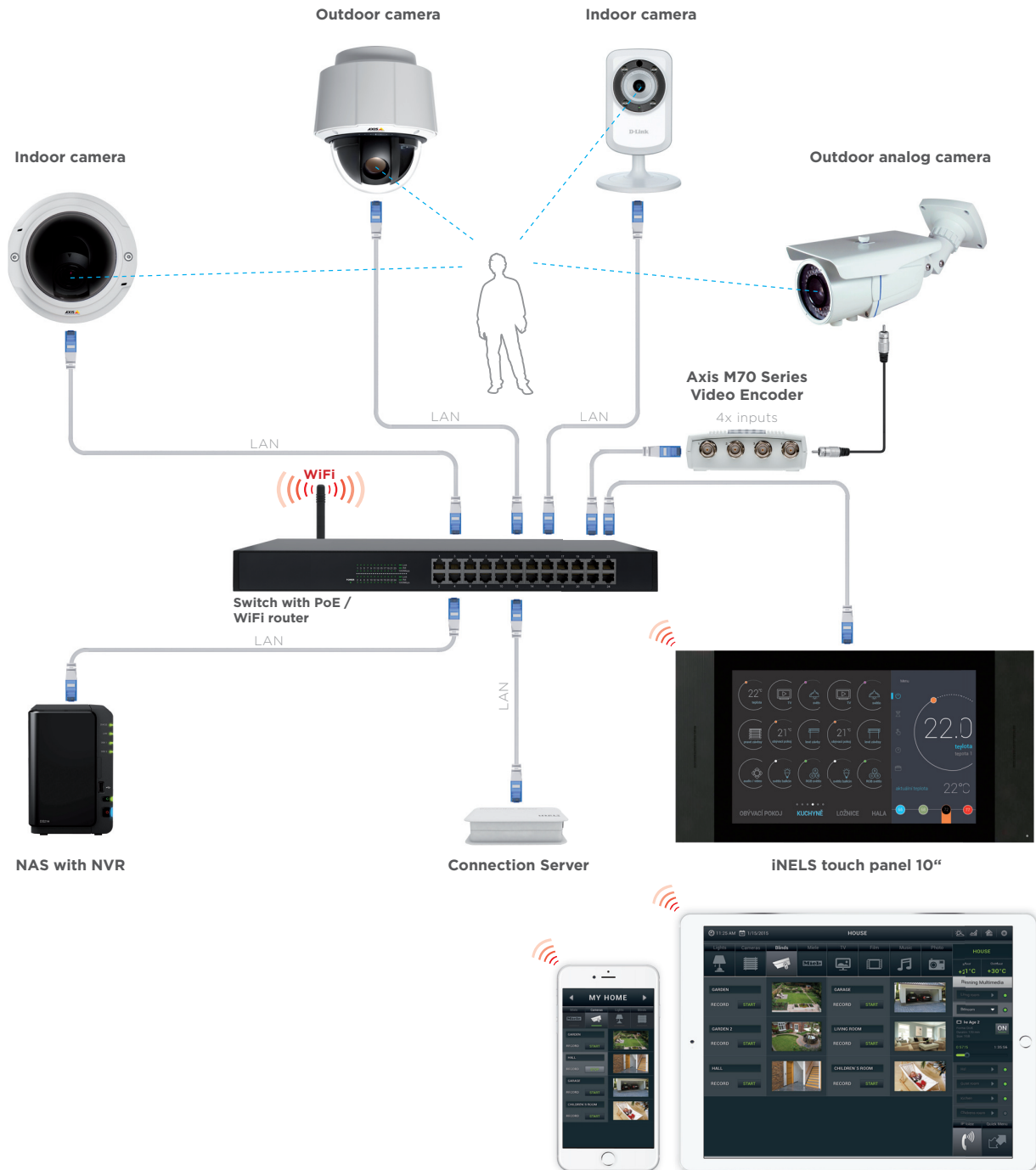

ONVIF protocol:



VAPIX protocol:



... and others ...
www.onvif.org

Air conditioning & Recuperation

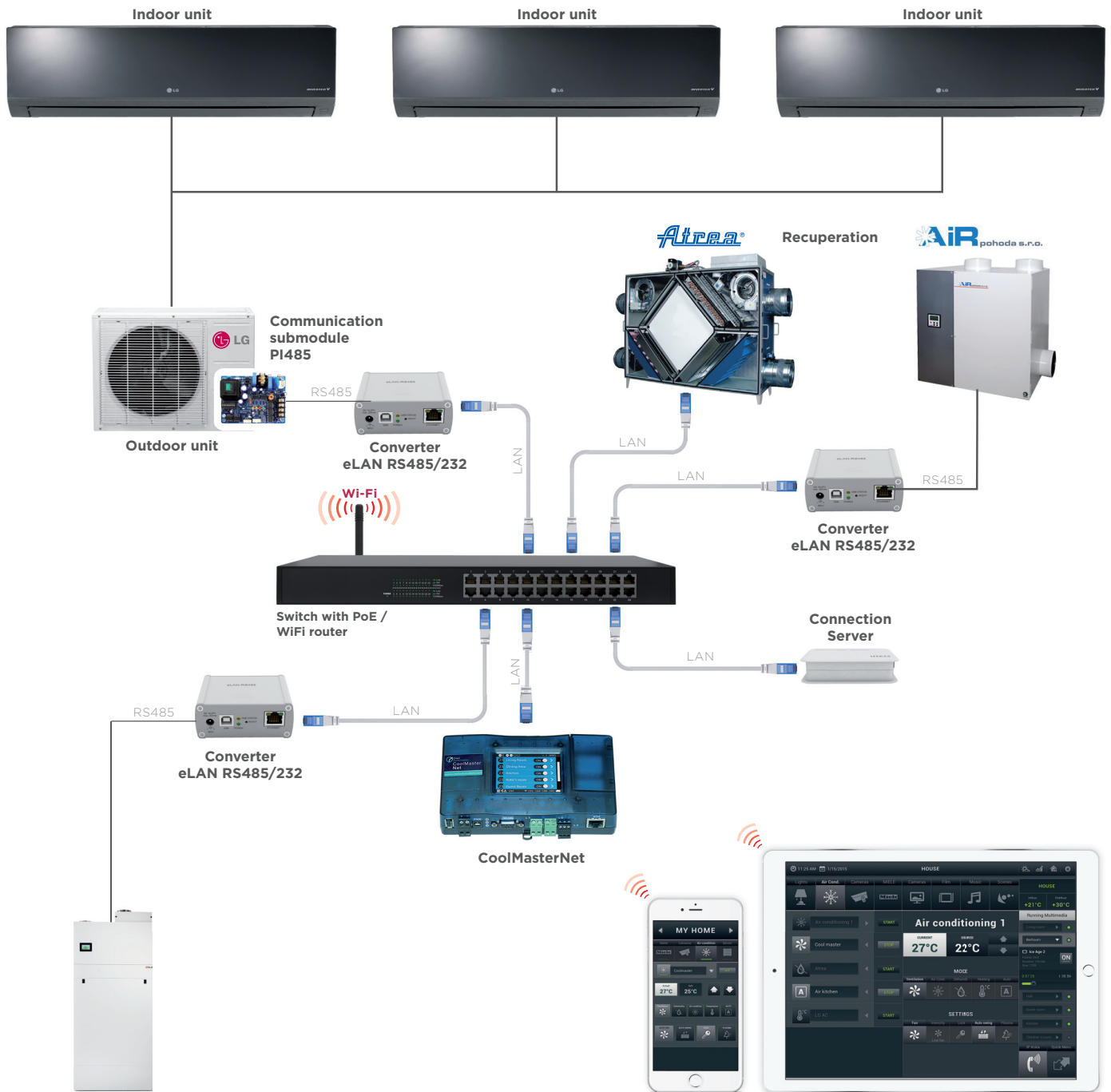

Via CoolMasterNet:



Energy measuring and weather stations

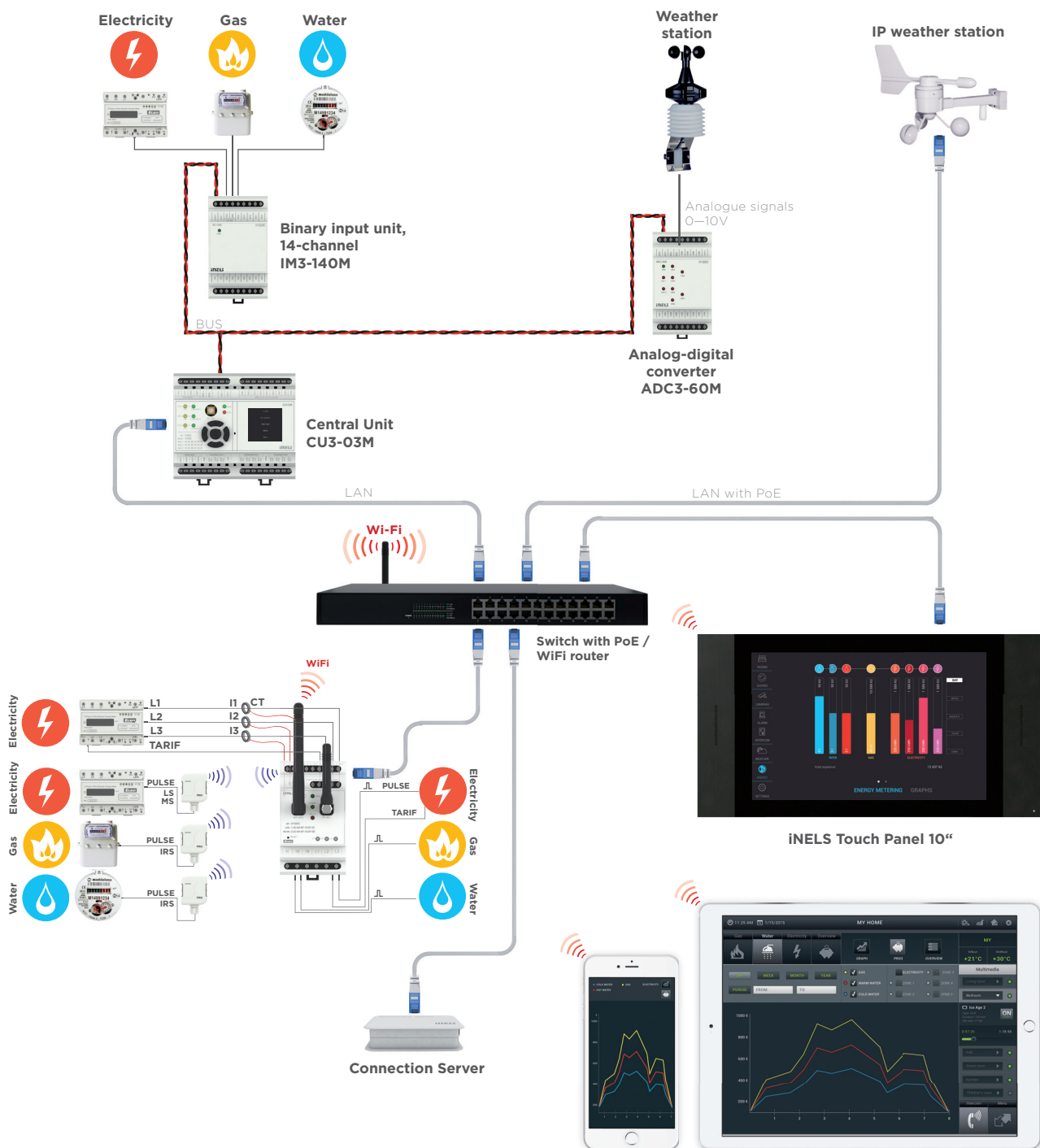

Overview of the energy consumption:

- it is possible to display the amount of consumed energy, price for this quantity and visualize it all in a clear chart

You can get this information:

- daily
- weekly
- monthly

- annually
- for a specific period

Clima sensor:

- measured quantities:
 - wind
 - precipitation
 - brightness (for South, East, West)
 - twilight
 - temperature
 - air humidity

IP weather station:

- measured quantities:
 - wind speed, wind direction
 - pressure
 - temperature
 - windchill
 - dew point
 - barometric altitude
 - relative humidity, absolute humidity

Infra red control

Stand alone solution



System solution

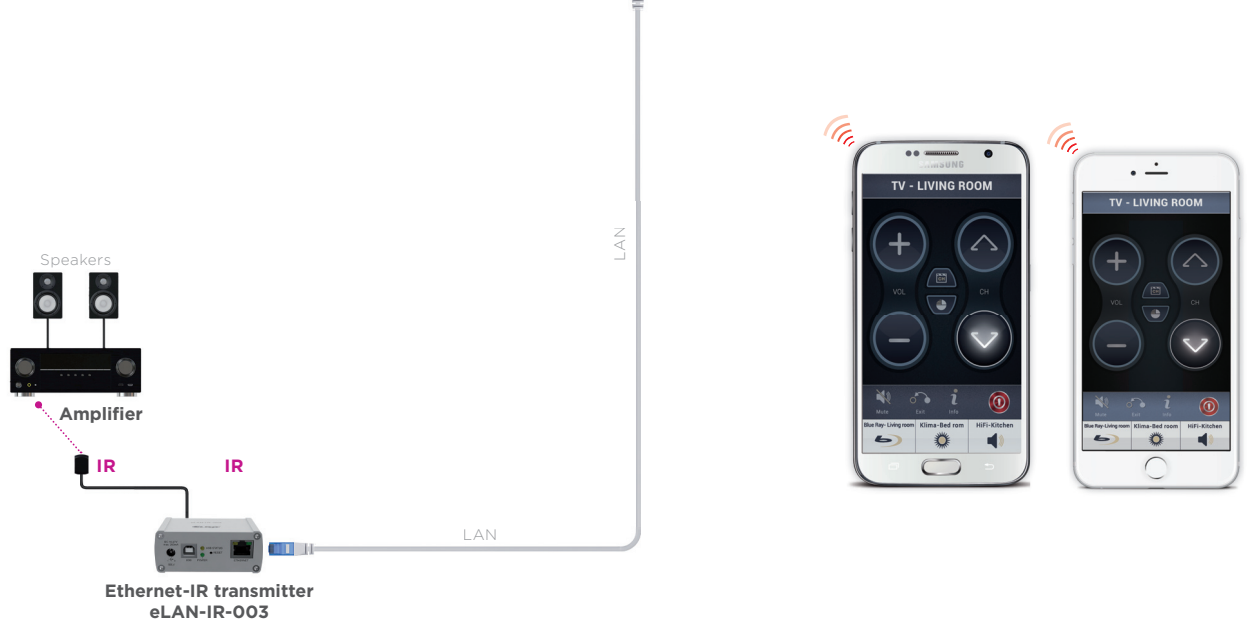

LARA control possibilities:

- it is possible to use Smart box eLAN-IR-003 in two ways:
 - stand-alone solution when Smartbox integrates all IR remote controllers under one – apps iHC-MAiR and iHC-MiIR
 - system solution when Smart box is used for IR remote control of eg. TV and amplifiers from complex apps iHC-MA,iHC-TA, iHC-MI and iHC-TI

BMS integrated with iNELS



PC



Laptop



Tablet



Smartphone

BMS
Building management system

powered by
niagara
framework®



iNELS BMS

OBIX
OPC
XML

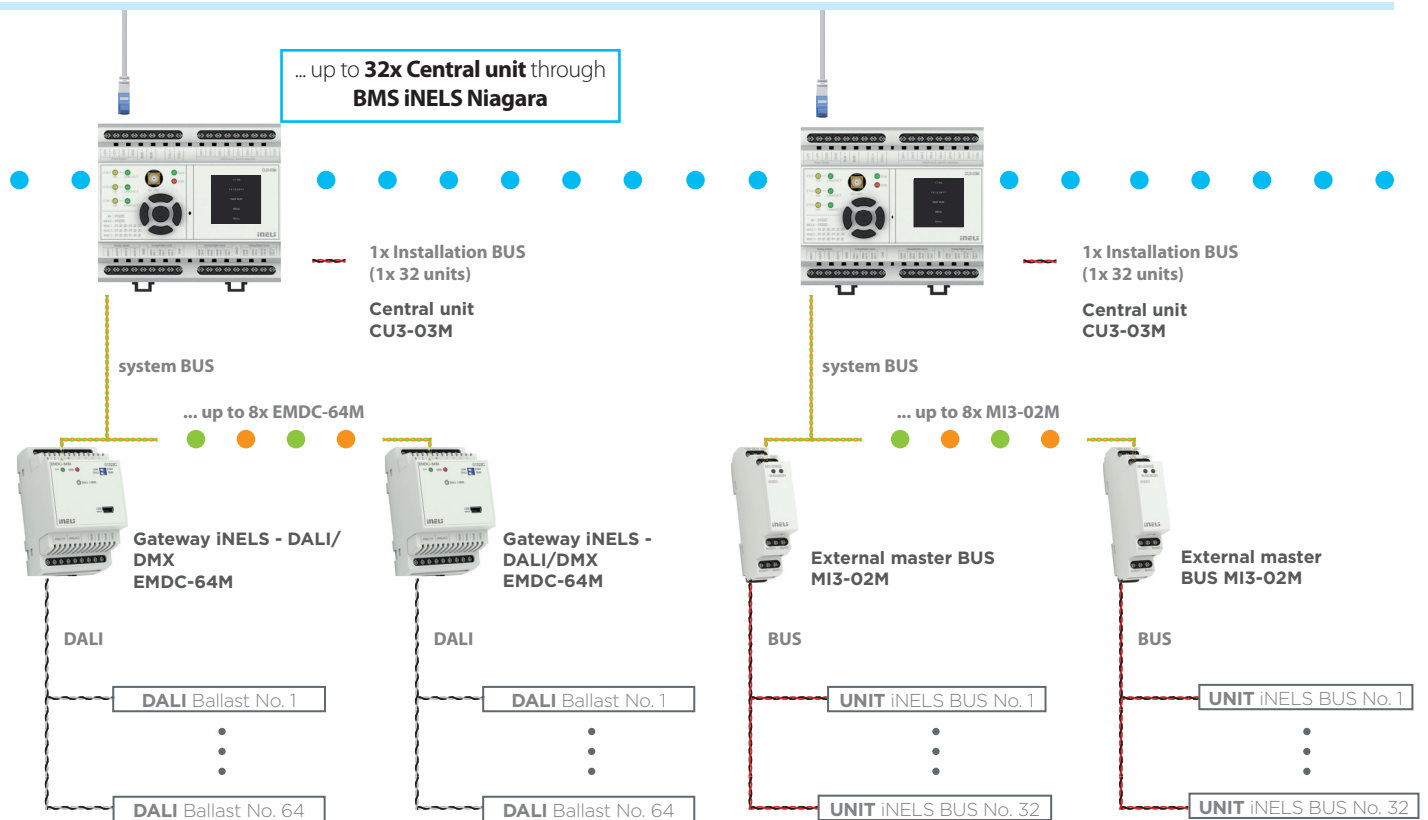

AVAILABLE PROTOCOLS: *



* A complete list can be found on www.inels.cz.

iNELS BUS & RF integration

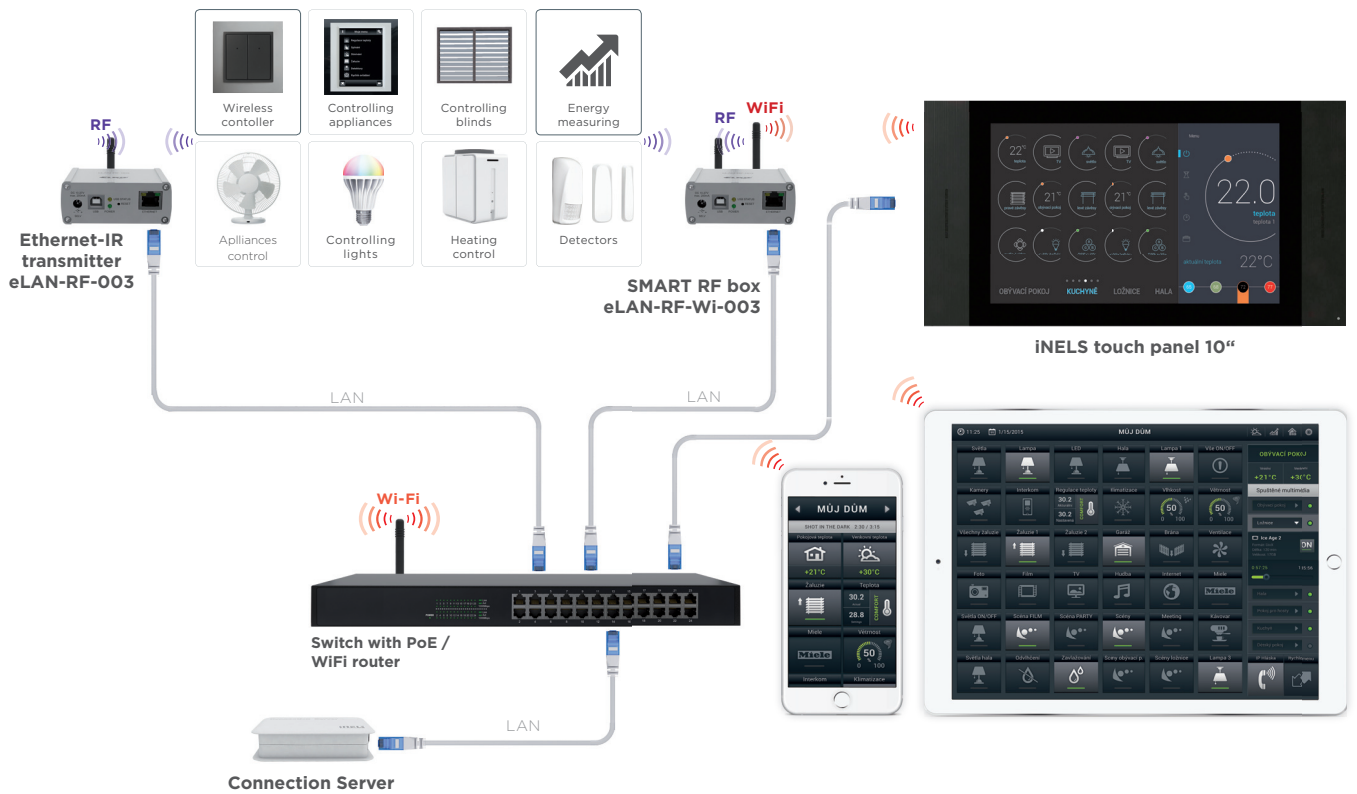

Control possibilities:

- using Smart RF box eLAN-RF (eLAN-RF-Wi), RF units can be controlled from iHC-MARF apps (Android smartphone) and iHC-MIRF apps (iPhone)
- using Connection Server RF units can be integrated into complex apps (so both BUS and RF can be controlled from one app) iHC-MA (Android smartphone), iHC-MI (iPhone), iHC-TA (Android tablet) and iHC-TI (iPad)
- using eLAN-RF (eLAN-RF-Wi) RF units can be controlled from Smart TV

Lighting control

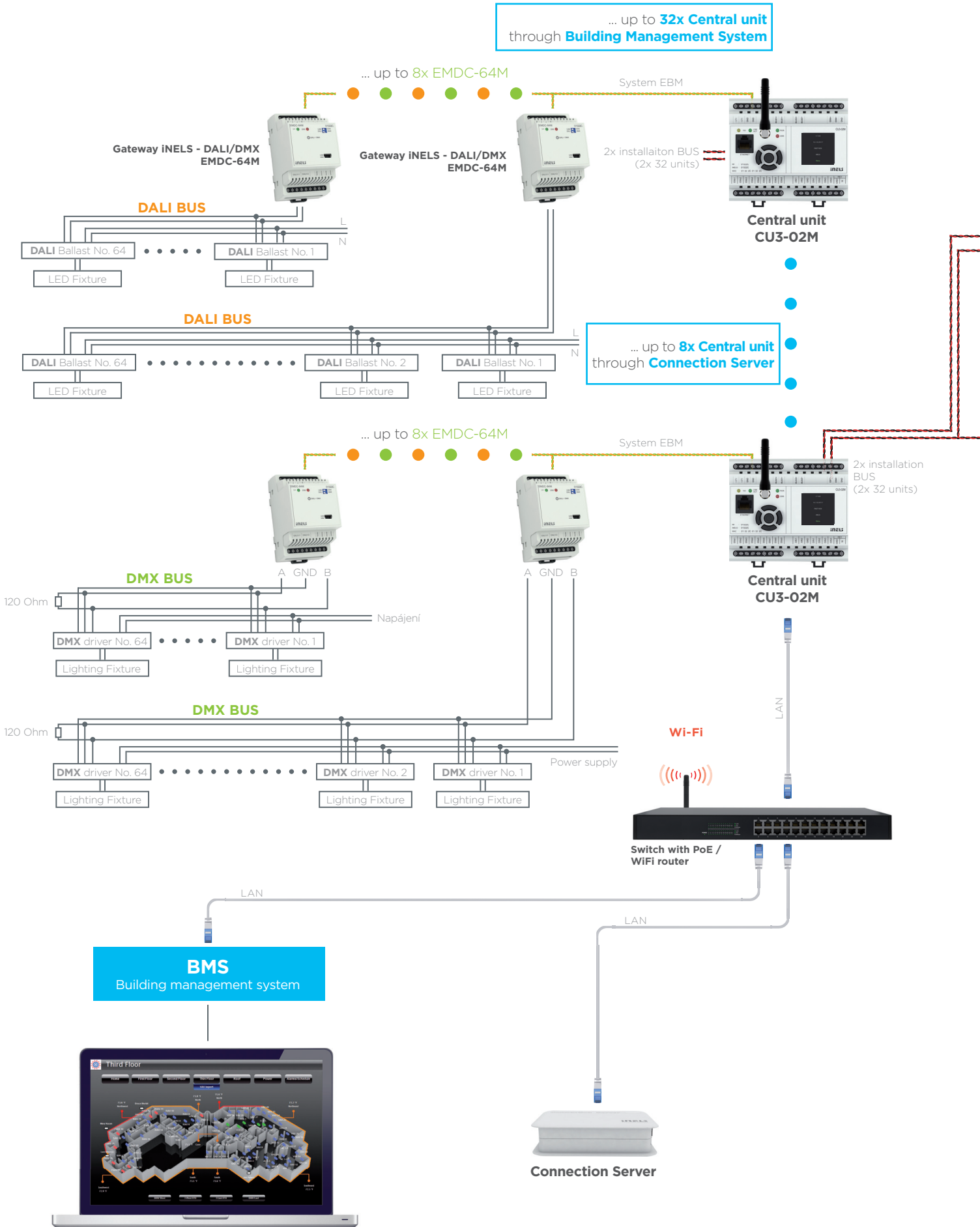

Wall switch buttons WSB3



Glass switch buttons with symbols GSB3

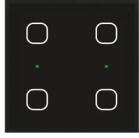

Elko smart touch screen EST3



Combined detector DMD3-1



Analog-digital converter ADC3-60M

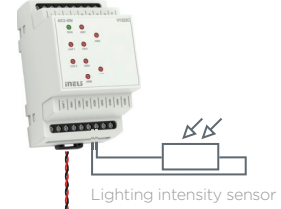

Lighting intensity sensor

Universal dimming actuator, 2-channel DA3-22M

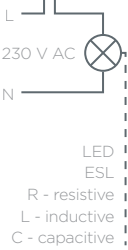

Dimming actuator for electronic ballasts, 2-channel LBC3-02M

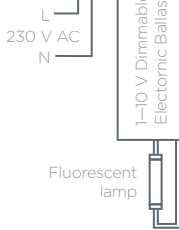

Digital-analog converter DAC3-04M

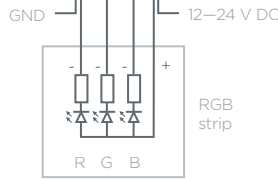

Dimming actuator for LED sources, 3-channel DCDA-33M

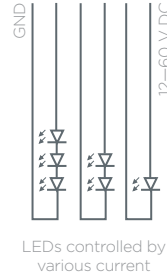

Switching actuators, 1-channel SA3-01B



Digital-analog converter DAC3-04B



DA3-06M Dimming actuator

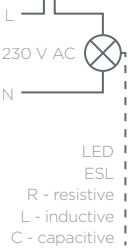

Apps for all

iNELS control everything from heating, ventilation and air-conditioning, lighting control, shielding control and other appliances up to security and access control system.

By applying applications iNELS Home Control (iHC) you have the whole building constantly under your thumb – right on the screen of your smartphone, tablet or panel. With iNELS you always have one eye on your home. Whenever and wherever you want.

Feature Summary



iNELS Home Control



Lighting



Blinds



Socket



Garage doors/gates



RGB bulbs/LED strips



Scenes



Heating



Cameras



Air-conditioning



Recuperation



Miele appliances



Weather station



Energy Metering



Intercom



A/V appliances





Overview

Absolute control over the state of all technologies.

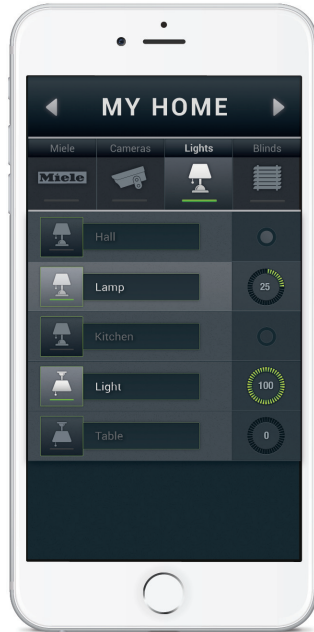

Lighting control

Easy adjustment of lighting atmosphere by one click – switching, dimming, colours.

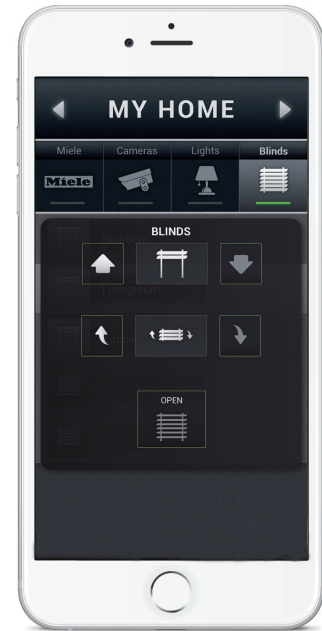

Shutters/Blinds

The possibility of individual or group control of shielding technology.



HVAC control

You can set the temperature in each room just the way you like.

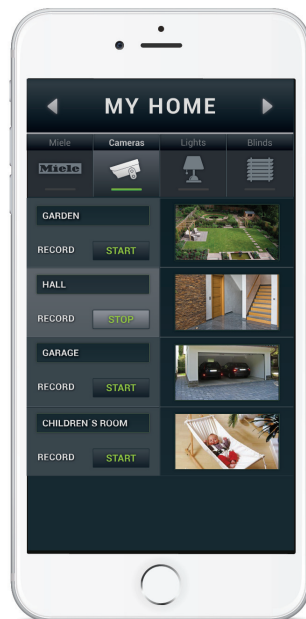

IP cameras

You can keep an eye on the security of your home from anywhere on earth.

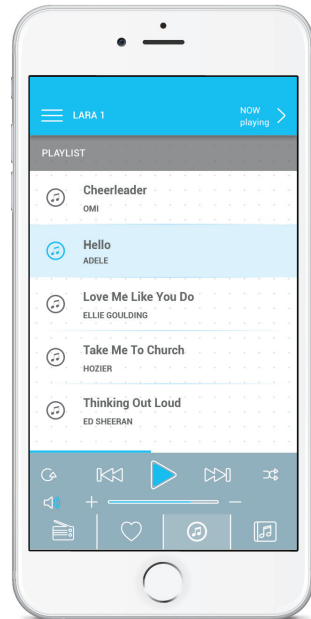

LARA

It is both quick and simple to play a music in desired zone.

iNELS References

Customer satisfaction is our primary goal and a positive reference the greatest reward. Since we began supplying iNELS, we have performed over 10,000 installations in residential and commercial buildings.

Hundreds of diverse but standardized solutions for apartments, houses and villas in dozens of countries around the world, fully remote-controlled squash centres in Hungary, restaurants in Prague, Bratislava (Slovakia), Moscow (RU), Istanbul (TR) or Sopron (HU), and a discotheque in Kiev (UA), a summer residence on Mallorca (ES), and wellness centres in Petrovice (CZ) and Buddha Palace in Bhutan or Hotels in Istanbul (TR), Dubai (UAE) or Cyprus. You can find our systems installed and Implemented in hundreds of locations across the globe.

We can introduce the iNELS system to various projects, whether it concerns the residential sector or commercial space.

Smart Home & Building Solutions for



Home



Hotel

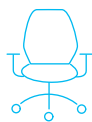

Future Office



Commercial

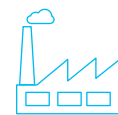

Industry



Smart City



Hotel Kempinski Bayterek

Almaty/Kazakhstan

- 5 star hotel
- lighting control in the public space
- more than 15 000 lights are controlled via DALI protocol
- lights scenes



Jamie's Italian Restaurant

Budapest/Hungary

- iNELS BUS System is controlling lighting and terrace-cooling/heating
- high voltage neon signs, lighting control



Badorka Balaton Aquarium

Balatonfured/Hungary

- iNELS controls all the lighting, for example the illumination of the aquariums
- speciality: there are no switches on the walls at all. Every light can be controlled via the 2 mounted tablets



Pest-Buda Bistro & Hotel

Budapest/Hungary

- The oldest hotel of Hungary, which was built in 1696
- 10 rooms with unique luxury equipment with heating & air-condition
- Furniture & equipment has been renovated a few years ago



Villa

Beskydy/Poland

- iNELS bus system
- meteostation
- lighting scenes
- using by tablet, smartphones and EST3



Hotel Wyndham

Istanbul/Turkey

- more than 3000 lighting circuits are controlled through the DALI protocol
- another thousand lighting circuits are controlled via DA3-22M units

System Units



Central unit

CU3-01M

- basic element of the system
- 2x BUS, 1x EBM BUS, 1x RF
- ethernet 100 Mbps
- 2x AI, 4x DI, 1x DO



Central unit

CU3-02M

- essential element of the system
- 2x BUS, 1x EBM BUS, 1x RF
- Ethernet 100 Mbps
- AI 2x, 4x DI, 1 DO
- RF submodule



External master BUS

MI3-02M

- allows to expand the system
- 2x BUS
- communicates with the central unit via EBM



BUS separator from power supply

BPS3-02M

- supply voltage: 27 V DC
- 2x BUS
- indication of output voltage outputs BUS LED

Switching Actuators



Shutters actuator, 2-channel

JA3-02B/DC

- controls shutters, blinds, awnings etc.
- switched voltage 12–24 V DC
- maximum load 0,85 A



Switching actuator, 2-channel

SA3-02M

- 2x changeover contacts 16 A/AC1
- switching voltage 250 V AC1, 24 V DC
- controls sockets, shutters, lights, appliances etc.
- rated current 50 mA from BUS



Switching actuator, 4-channel

SA3-04M

- 4x changeover contacts 16 A/AC1
- switching voltage 250 V AC1, 24 V DC
- controls sockets, shutters, lights, appliances etc.
- rated current 70 mA from BUS



Switching actuator, 6-channel

SA3-06M

- 6x changeover contacts 8 A/AC1
- switching voltage 250 V AC1, 24 V DC
- controls thermostats, lights, appliances etc.
- rated current 60 mA from BUS

Dimming Actuators



Universal dimming actuator, 2-channel

DA3-22M

- 2-channel universal dimming actuator
- load type: LED, ESL, resistive, inductive, capacitive
- maximum load: 400 VA for each channel
- rated current 10 mA from BUS



Dimming actuator for electronic ballasts, 2-channel

LBC3-02M

- two-channel actuator for fluorescent lamps
- analog outputs automatically control relays
- 2x 0(1)–10 V, 2x changeover contacts 16 A/AC1
- rated current 60 mA from BUS



Dimming actuator for LED sources, 3-channel

DCDA-33M

- three-channel actuator for LED controlled by variable current
- dimming load 12–60 V DC
- controlled via BUS, DALI or DMX



Dimming actuator for LED (RGB) strips, 3-channel

RFDA-73M/RGB

- dimmer (RGB) LED strips
- component power 12-24 V DC
- maximum load 3x 5 A
- control signal 0 (1) - 10V (drive DAC3)
- ability to control over BUS

Shutter Actuators



Gateway iNELS - DALI/DMX

EMDC-64M

- iNELS to DALI/DMX converter
- controls up to 64 DALI or DMX lighting ballasts
- communicates with the central unit via EBM



GSM communicator

GSM3-01M

- GSM gateway for communication between iNELS and GSM mobile phones
- supports up to 512 number
- communicates with the central unit via EBM



Power supply

PS3-100/iNELS

- power supply 100 W
- supply voltage 100-250 V AC
- output 1: 27,6 V/ 3,6 A
- output 2: 12,2 V/ 0,35 A



Shutter actuator, 18-channel

JA3-018M

- 18-channel shutter actuator
- controls shutters, blinds, awnings etc.
- switched voltage 250V AC
- maximum load 4 A/AC 15 for each channel



Switching actuator, 12-channel

SA3-012M

- 12x NO contacts 8 A/AC1
- switching voltage 250 V AC1, 30 V DC
- controls thermostats, lights, appliances etc.
- rated current 20 mA/230 V AC



Switching actuator, 22-channel

SA3-022M

- 12x NO contacts 6 A/AC1
- 4x NO contacts 10 A/AC1
- 4x SSR contactless 2 A/AC1
- equipped with 22 relay outputs
- switching lighting and socket circuits



Switching actuator, 1-channel

SA3-01B

- 1x NO contact 16 A/AC1
- switching voltage 250 V AC1, 24 V DC
- controls sockets, thermostats, lights, appliances etc.
- rated current 30 mA from BUS



Switching actuator, 2-channel

SA3-02B

- 2x changeover contacts 8 A/AC1
- switching voltage 250 V AC1, 24 V DC
- controls shutters, lights, appliances etc.
- rated current 50 mA from BUS

Converters



Dimming actuator, 6-channel

DA3-06M

- 6-channel universal dimming actuator
- load type: LED, ESL, resistive, inductive, capacitive
- maximum load: 150 VA for each channel
- rated current 10 mA from BUS



Analog-digital converter, 6-channel

ADC3-60M

- integration of sensors with analog outputs
- 6x analog inputs
- supports voltage, current and resistance signals
- rated current 100 mA from BUS



Digital-analog converter, 4-channel

DAC3-04B

- generates analog voltage signal
- 4x analogue output
- controls e. g. RFDA-73M/RGB
- rated current 50 mA from BUS



Digital-analog converter, 4-channel

DAC3-04M

- generates analog voltage signal
- 4x analog output
- controls e. g. RFDA-73M/RGB
- rated current 50 mA from BUS

Glass Touch Controllers

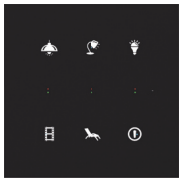

Glass switch button with symbols

GSB3-40/S, GSB3-60/S
GSB3-80/S

- Glass touch controllers with symbols
- All versions are in the size of the module (94x94 mm)
- Individual symbols can be illuminated in one of seven colours
- rated current 25–40 mA from BUS

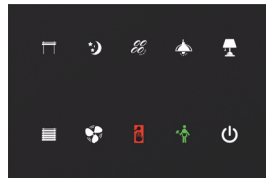

Glass switch panel

GSP3-100/B, GSP3-100/W

- Glass Touch Panel GSP3-100 is part of a comprehensive INELS series of units for the management of the hotel rooms
- ten touch buttons
- rated current 25–65 mA from BUS

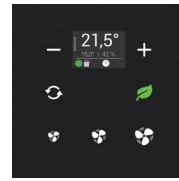

Glass room thermo-regulator

GRT3-50/B, GRT3-50/W

- display for displaying the current room temperature
- GRT3-50 is also suitable for controlling fan-coils
- Thermo-regulator is equipped with an integrated temperature sensor

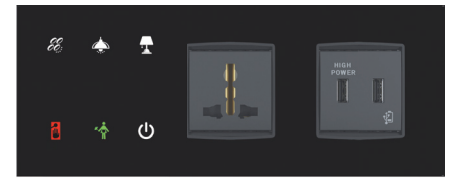

Glass bedside panel

GBP3-60/B, GBP3-60/W

- GBP3-60 panel is equipped with six customizable touch buttons
- control units for guest room management system

Standard (plastic) Controllers



Wall switch button

WSB3-20, WSB3-20H

- 2 push-buttons, design LOGUS⁹⁰
- integrated temperature sensor
- one colours signalization LEDs
- rated current 25 mA from BUS



Wall switch button

WSB3-40, WSB3-40H

- 4 push-buttons, design LOGUS⁹⁰
- integrated temperature sensor
- two colours signalization LEDs
- rated current 25 mA from BUS



Digital room thermo-regulator

IDRT3-1

- digital thermo-regulator
- measures and controls temperature in room
- rated current 20 mA from BUS
- design LOGUS⁹⁰

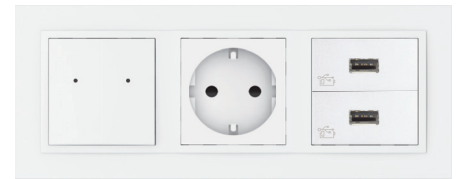

Bedside panel

WSB3-40, Schuko,
2x USB supply unit

- design LOGUS⁹⁰
- configure according to your request

Audio

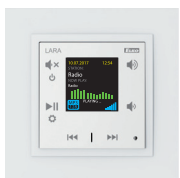

Music player

LARA Radio

- plays the stream of internet radios and music from NAS or external source or DLNA
- equipped with an internal amplifier 2x 10 W

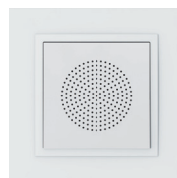

LOGUS speaker

Into a frame

- dimensions (mm): \varnothing 50.8
- maximum output: 10 W
- impedance: 32 Ω
- design LOGUS⁹⁰



Ceiling speaker

Into a suspended ceiling

- dimensions (mm): \varnothing 127
- maximum output: 30 W
- impedance: 8, 16, 32 Ω
- colour: white

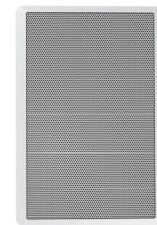

Wall speaker

On the wall

- dimensions (mm): 270 x 183 x 37
- maximum output: 15 W
- impedance: 8, 16, 32 Ω
- colour: white

Access Control



Glass bedside panel

GBP3-60/BR/1F-26B

- GBP3-60 panel is equipped with six customizable touch buttons
- control units for guest room management system



Elko hotel touch screen

EHT3

- touch screen panel with 3.5" display
- controls temperature, lighting, shading, scenes
- LOGUS⁹⁰ design
- rated current 150 mA from BUS

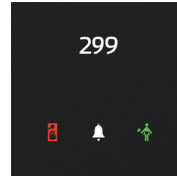

Glass card reader

GCR3-11/B, GCR3-11/W

- The RFID card reader is a great design for the entrance to the rooms which also features a bell signal the "Do Not Disturb" and "Make Up Room" signs.

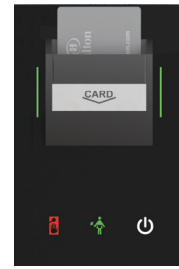

Glass card holder

GCH3-31/B, GCH3-31/W

- In-room card holder with RFID reader which detects correct card and eliminates fake cards. Optional 3 buttons: "Do Not Disturb", "Make Up Room" and "Master Off".

Access Control



Elko smart touch screen

EST3

- touch screen panel with 3.5" display
- controls temperature, lighting, shading, scenes
- LOGUS⁹⁰ design
- rated current 150 mA from BUS

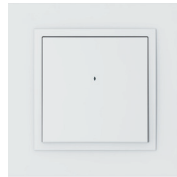

Wall card reader

WMR3-21

- RFID card reader 13.56 MHz
- NFC ready
- 2 push-buttons, LOGUS⁹⁰ design
- rated current 50 mA from BUS



Card holder

90731 TBR

- After inserting hotel card to card switches it will activate automatic regulation of the lights in the room.

Detectors



Combined detector

DMD3-1

- power: 27 V DC (iNELS BUS)
- combined detector
- used: motion detector, sensor luminescence



Motion detector

MD-100

- power: 1x 1,5 V AAA battery
- detection angle 120°
- shot length 12 m (13.12 yd)



Luminescence sensor

DLS3-1

- power: 27 V DC (iNELS BUS)
- the luminescence sensor
- DLS3-1 sensor is supplied in IP65

System units



Ethernet-IR transmitter

eLAN-IR-003

- the applications iHC-MAIR and iHC-MIIR provide universal control for all Audio/Video devices
- you can connect three sensors to the smart IR box eLAN-IR-003 for
- three directions of control



Smart RF box

eLAN-RF-003

- smart box for controlling devices equipped with an IR receiver through apps
- controls televisions, amplifiers, projectors satellite receivers A/C etc.
- 3 IR transmitters, up to 100 commands



Smart RF box Wi-Fi

eLAN-RF-Wi-003

- The smart RF box enables you to control your electrical installation by smartphone, tablet or SMART TV
- Option of setting via web interface or directly in the application iHCMAIRF (Android) / iHC-MIIRF (iPhone).



Converter eLAN RS485/232

eLAN-RS485/232

- Used to communicate with devices via the Modbus RTU protocol
- The web interface enables the control of connected devices

Video door phone



Door communicator

2N HELIOS BASE

- door communicator 2N Helios door entry system with camera for smaller installations with a built-in camera and one or two buttons
- you can choose from two variants of contactless RFID reader



Door communicator

2N HELIOS IP VERSO BASIC

- basic module series offers higher specification camera with IR illumination and night vision
- watchtower with multifunction modules can be changed according to customer needs
- you can choose mechanical illuminated keys, a numeric keypad or infopanel



Videotelefon Dahua

DAHUA VTO2000A IP

- fully compatible with the iNELS RF Control applications iHC-MAIRF and iHC-MIIRF
- connections through Connection server



IP camera

ONVIF

- power: 5 V DC adapter
- resolution: 640 x 480 px
- night light
- up to 10 cameras in app

Accessories iNELS



Thermodrive

TELVA 230 V

- operating voltage: 230 V, 50/60 Hz
- stopping force: 100 N ±5%
- dimension h/w/l: 55+5 x 44 x 61 mm (2.17 + 0.2 x 1.73 x 2.40 in)



Thermodrive

TELVA 24 V

- operating voltage: 24 V AC, 50/60 Hz
- stopping force: 100 N ±5%
- dimension h/w/l: 55+5 x 44 x 61 mm (2.17 + 0.2 x 1.73 x 2.40 in)



Flood probe

FP1

- the water leakage sensor warns against flooding of the bathroom
- length of cable 3 m (3.3 yd)



Thermo sensors

TC

- range: 0 - 70 °C (32 - 158°F)
- sensor: NTC 12 K 5%
- TC-0 - l. 110 mm (4.33 in)
- TC-3 - l. 3 m (1.42 yd)
- TC-6 - l. 6 m (1.75 yd)
- TC-12 - l. 12 m (13.12 yd)

Weather stations



Weather station

Clima sensor D WTF

- provides up to 8 voltage analogue signals about weather conditions
- a full range of applications
- wind speed, temperature, humidity, twilight, precipitation, brightness (east, south, west)



Weather station

Giom 3000

- a simpler version of IP weather station
- wind speed, wind direction, temperature, relative humidity, absolute pressure, altitude, Windchill, absolute humidity, dew point

Air conditioning



A/C controllers

CoolMasterNet

- communication bridge that seamlessly connects advanced VRF/VRV Air Conditioning Systems and iNELS



LG A/C controllers

PI485

- gateway that provides communication between LG Outdoor Units and iNELS
- there are two types with support up to 16 or 48 indoor units



Thermo sensors

TZ

- range: -40 - 125 °C (-40 - 257°F)
- sensor: NTC 12 K 5%
- TZ-0 - l. 110 mm (4.33 in)
- TZ-3 - l. 3 m (1.42 yd)
- TC-6 - l. 6 m (1.75 yd)
- TC-12 - l. 12 m (13,12 yd)



iNELS BUS cable

- twisted shielded pair 0,8 mm
- cable has been designed specifically for usage in iNELS system
- it provides the best parameters for wiring of installation BUS
- twisted pair of wires, diameter AWG20

Product dimensions

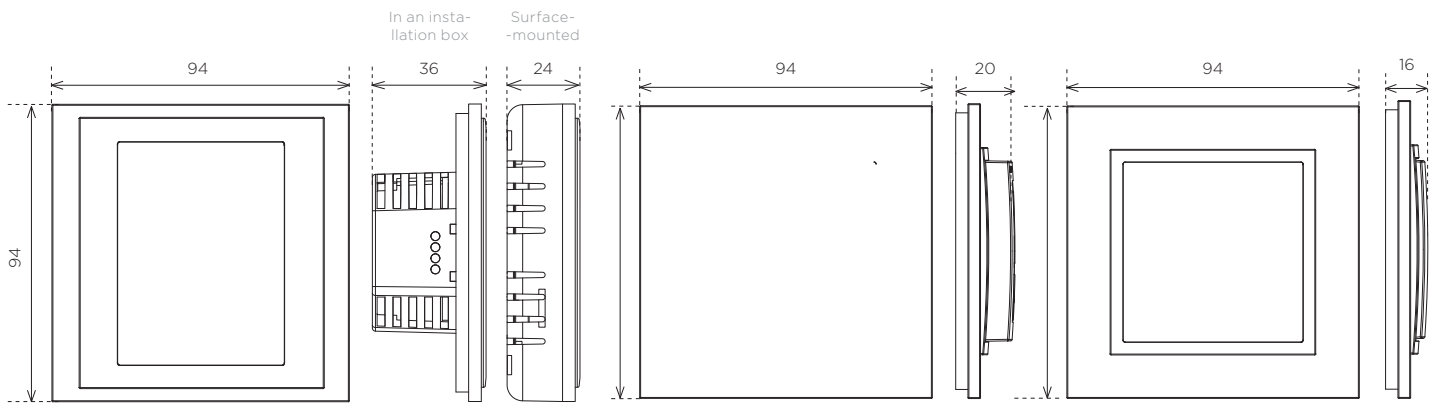

EST3

GSB3-40 GMR3-61
GSB3-60 GHR3-11
GSB3-80

WSB3-20 WSB3-20H
WSB3-40 WSB3-40H
WMR3-21 IDRT3-1

6 Modul

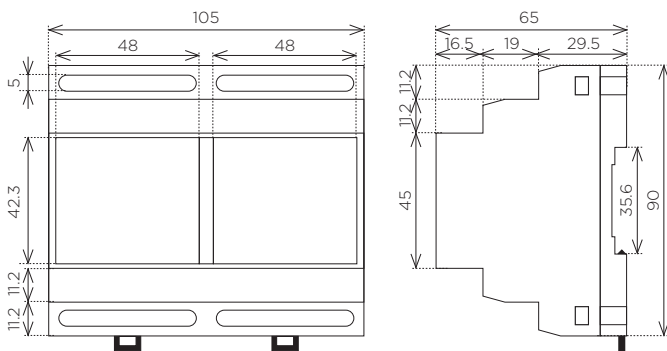

CU3-01M PS3-100/iNELS
CU3-02M SA3-012M

3 Modul

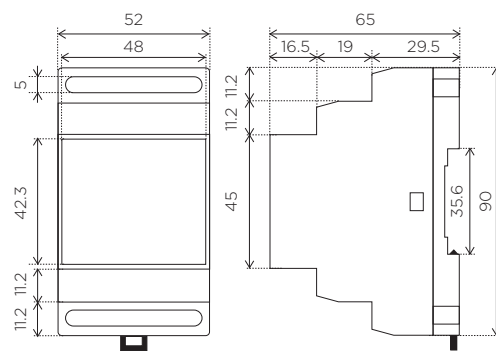

EMDC-64M SA3-06M DCDA-33M TI3-60M
GSM3-01M DA3-22M RFDA-73M ADC3-60M
SA3-04M LBC3-02M IM3-140M DAC3-04M

1 Modul

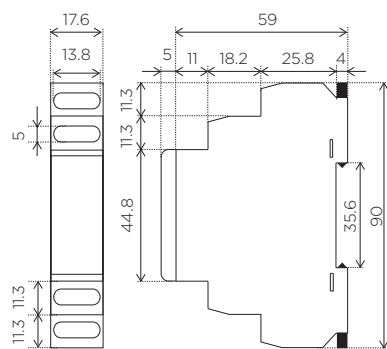

MI3-02M BPS3-01M
SA3-02M BPS3-02M

MINI

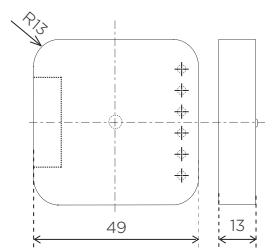

JA3-02B/DC TI3-10B
IM3-20B TI3-40B
IM3-40B DAC3-04B
IM3-80B

MINI

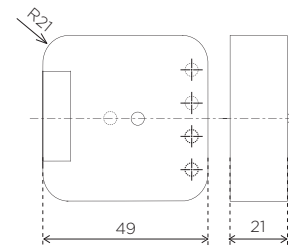

SA3-01B
SA3-02B

Installation options

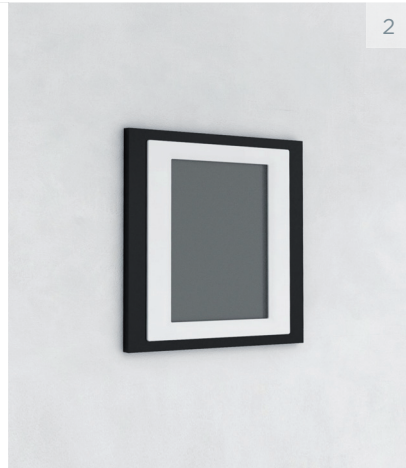

1) Wall mounting

Wall mounting or installation in the installation box with a spacing of 65 mm.

RFWB-20/G RF Touch
RFWB-40/G

2) Prebuilt storages in the wall

RF Touch EHT3
WSB3-20 GCR3
WSB3-40 GSB3-40
WSB3-20H GSB3-60
WSB3-40H GSB3-80
IDRT3-1 GMR3-61
EST3

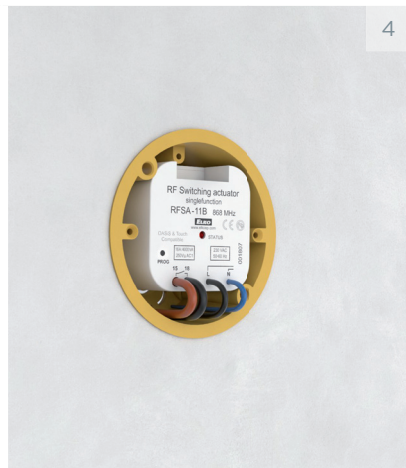
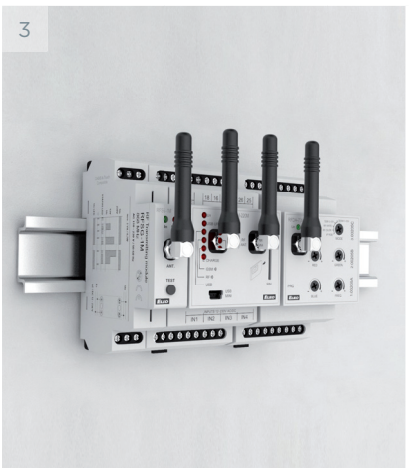

3) Installation on DIN rail

DIN rail according to EN 615.

CU3-01M	DAC3-04M	RFSA-66M
CU3-02M	SA3-04M	RFDEL-71M
PS3-100/	SA3-06M	MI3-02M
iNELS	DA3-22M	BPS3-01M
SA3-012M	LBC3-02M	BPS3-02M
DIM-6	DCDA-33M	SA3-02M
EMDC-64M	RFDA-73M/	RFSA-61M
IM3-140M	RGB	

4) Installation into the installation box

Mounted in an installation box or built into the device.

RFSA-11B	SA3-02B
RFSAI-61B	SMR-S
RFSA-62B	SMR-U
RFDEL-71B	SMR-M
SA3-01B	IM3-20/40/80B



5) Installation in the housing

RFSA-11B	SA3-02B
RFSAI-61B	SMR-S
RFSA-62B	SMR-U
RFDEL-71B	SMR-M
SA3-01B	

6) Wall mounting

DLS3-1
SOU-3
RFSOU-1

Others just resell
HOWEVER, WE DEVELOP AND MANUFACTURE
PRODUCTS OURSELVES!

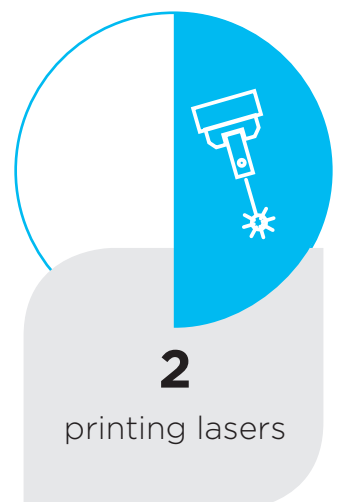
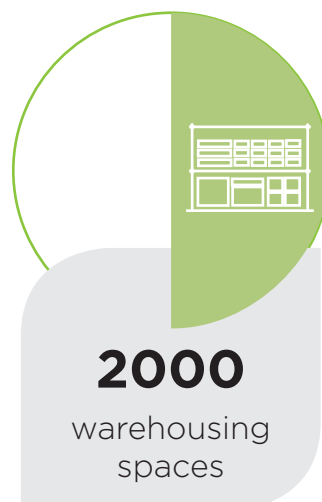
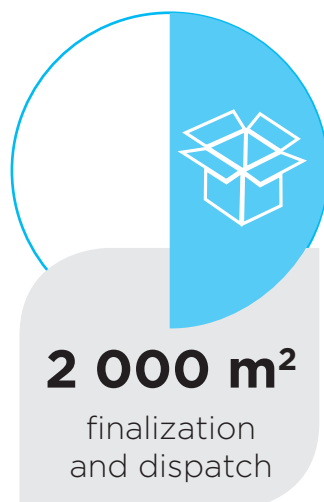
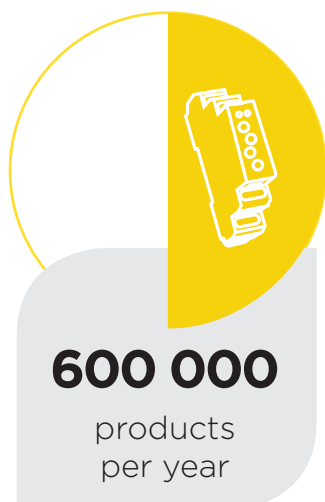
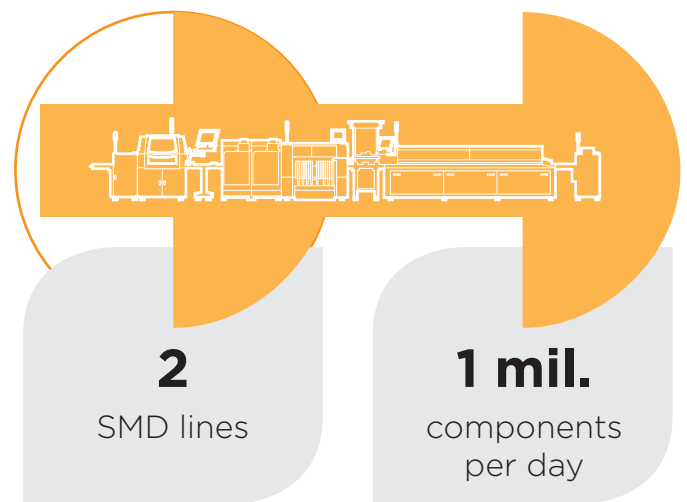
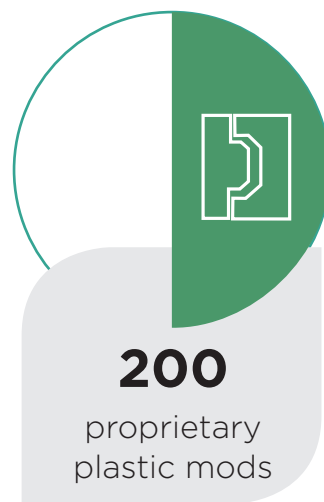
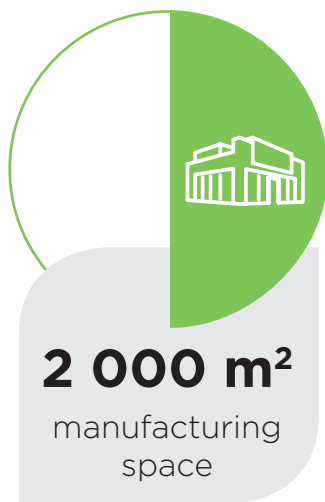
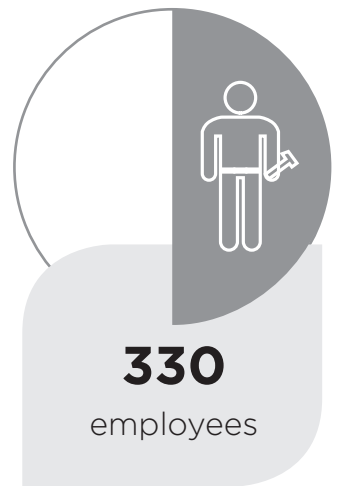
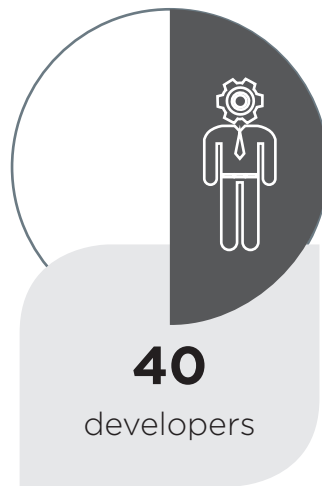



R&D overall view



Manufacturing hall



Testing lab



Finalization and dispatch

ELKO EP Holding

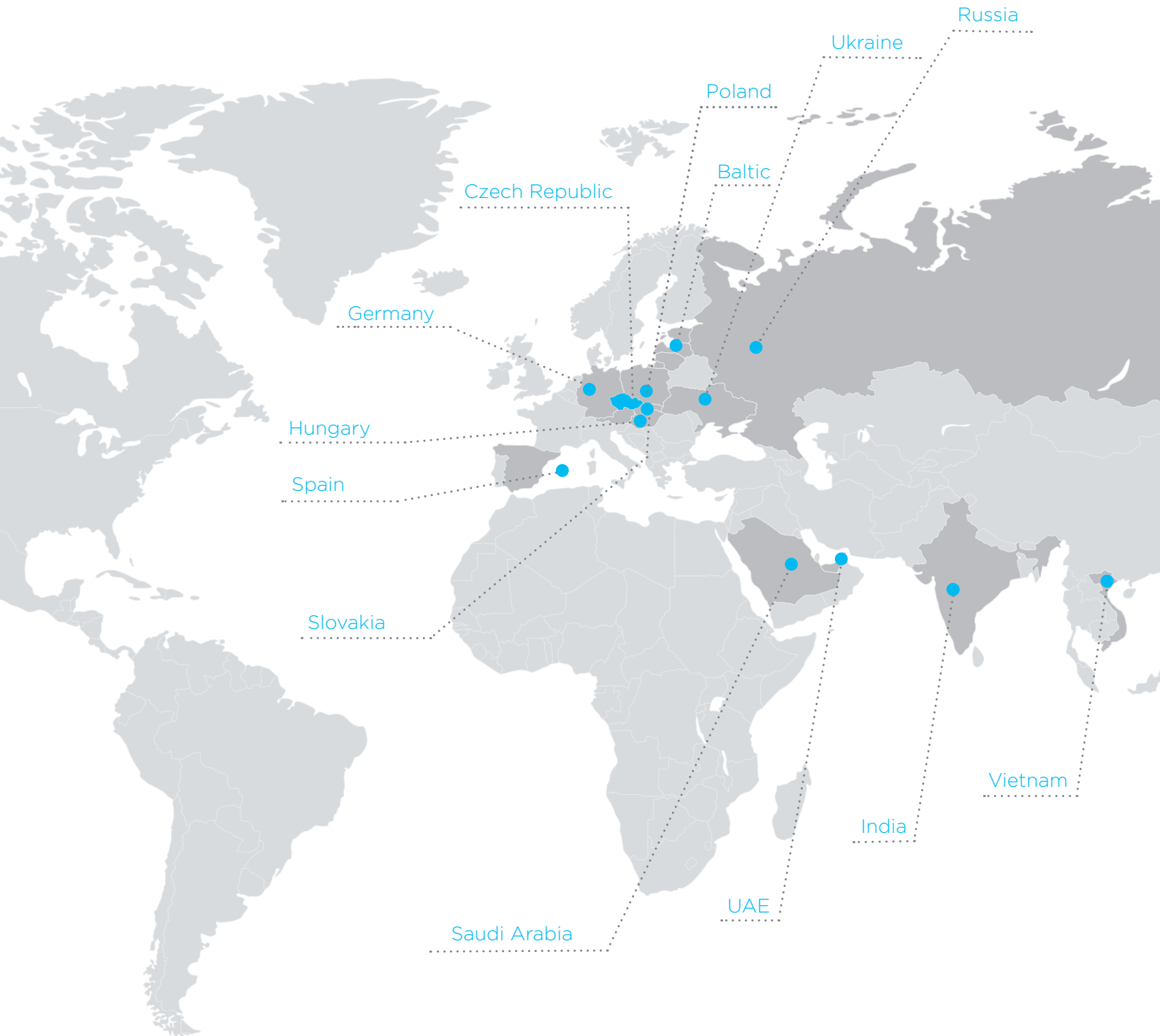

www.elkoep.com

Published: 01/2019 | 1st edition
Modifications or amendments reserved.